

# 2022

## PERFORMANCE COMPONENTS

BIKE



**MAGURA**



Photo: Philip Ruopp



.....

## ÜBER MAGURA ABOUT MAGURA

**4**

MAGURA ORIGINAL SPARE PARTS	4
MAGURA TECHNOLOGIE MAGURA TECHNOLOGY	6

.....

## PRODUKTE PRODUCTS

**8**

PRODUKTÜBERSICHT PRODUCT OVERVIEW	8
SCHEIBENBREMSEN DISC BRAKES	10
FELGENBREMSEN RIM BRAKES	28
S-PEDELEC BREMSEN S-PEDELEC BRAKES	34

.....

## TUNING PARTS TUNING PARTS

**40**

BREMSHEBEL LEVER BLADES	42
BLENDEN-RING KITS RING-KITS	44
INDIVIDUELLE COVER INDIVIDUAL COVERS	44
KLEMMSCHELLEN HANDLEBAR CLAMPS	45

.....

## ORIGINAL SPARE PARTS ORIGINAL SPARE PARTS

**46**

ÜBERSICHT BREMSBELÄGE BRAKE PADS OVERVIEW	49
BREMSBELÄGE BRAKE PADS	50
BREMSSCHEIBEN ROTORS	51
ADAPTER ADAPTER	54
SERVICE PRODUKTE SERVICE PRODUCTS	56

.....

## BEKLEIDUNG APPAREL

**58**

GESPONSERTE FAHRER SPONSORED RIDERS	66
PRODUKTTABELLE: BREMSEN PRODUCT TABLE: BRAKES	68
OEM PARTNERS OEM PARTNERS	69

# MAGURA ORIGINAL SPARE PARTS

# BEST PARTS = BEST BRAKING PERFORMANCE

Service und Qualität – MAGURA Originalersatzteile bedeuten nicht nur schwäbische Qualität, auf die man sich verlassen kann, sondern auch einen hervorragenden Service: Alle Produkte werden in einem unserer vier europäischen MAGURA Servicecenter sowie bei unseren Tochterfirmen in den USA und Asien repariert. Wer könnte wichtige Komponenten wie Bremsen und Federgabeln wohl besser reparieren und wieder in Topzustand versetzen als die Fachleute aus dem eigenen Haus!

Damit du dich auch nach Jahren des Einsatzes auf die Bremsen verlassen kannst, gibt es die MAGURA Original Spare Parts. Die Ersatz- und Verschleißteile garantieren maximale Performance und Sicherheit. Zum Programm gehören Bremsscheiben in allen gängigen Größen und Bremsbeläge für jeden Einsatz, von Comfort über Performance bis hin zu Race. Der Bremsbelagstausch bei der MT-Serie geht leicht von der Hand: Verschlossene Bremsbeläge lassen sich dank des MAGURA magnetiXchange Systems blitzschnell austauschen.

Zuverlässigkeit setzt sich auch in der Wahl der Materialien fort. Deshalb arbeiten alle hydraulischen Bremssysteme von MAGURA mit Mineralöl, dem MAGURA Royal Blood. Größter Vorteil: Royal Blood zieht kein Wasser, altert nicht und muss nicht wie DOT Bremsflüssigkeit periodisch gewechselt werden. Zudem werden durch Royal Blood die Lackierung oder Materialien nicht beschädigt.

Service and quality – MAGURA Original Spare Parts mean not only swabian quality you can rely on, but also excellent service: All products are repaired in one of the four European MAGURA service centres as well as at our subsidiaries in the US and Asia. Who else is able to repair important components such as brakes and suspension forks and to restore them to top condition better than our in-house experts?

MAGURA Original Spare Parts are always available, so you can rely on the brakes even after years of use. Our spare and wear parts guarantee maximum performance and safety. The range includes rotors in all common sizes, and brake pads for every use from comfort and performance to racing. Replacing worn MT series brake pads is oh-so-easy thanks to the MAGURA magnetiXchange system.

MAGURA's choice of materials is also oriented on reliability – and this is why all hydraulic braking systems from MAGURA use mineral oil – the renowned MAGURA Royal Blood. Its biggest advantage? Royal Blood does not age or draw water, and in contrast to DOT brake fluids, it doesn't have to be periodically bled off and refilled. Royal Blood also does not damage paintwork or materials.

## MAXIMALE BREMSPOWER

Mit dem Einsatz von MAGURA original Bremsscheiben und -belägen erzielst du die maximale Bremspower. Denn unsere Komponenten sind bezüglich Material und Technologie optimal aufeinander abgestimmt.

## GLEICHBLEIBENDE QUALITÄT

Alle MAGURA Originalersatzteile unterliegen ständigen Qualitätskontrollen und sind von gleichbleibend hoher Güte und Qualität.

## 5 JAHRE GARANTIE

MAGURA bietet eine fünfjährige Dichtigkeitsgarantie für alle MAGURA Bremsgriffe und Bremszangen/-zylinder, sofern sie ausschließlich mit MAGURA Originalersatzteilen bestückt sind.

## MAXIMUM BRAKING POWER

You'll get maximum braking power using original MAGURA rotors and brake pads – because our components are optimally matched to each other in terms of material and technology.

## CONSISTENT QUALITY

All MAGURA Original Spare Parts are subject to constant quality controls and ensuring consistently high quality.

## 5 YEARS GUARANTEE

MAGURA offers a five-year leak proof guarantee for all MAGURA brake masters and brake calipers / cylinders, provided they are exclusively equipped with original MAGURA Spare Parts.



Photo: Philip Ruopp

# MAGURA TECHNOLOGY

## MAGURA Technologie – Materialien

Sowohl in der Motorrad- als auch in der Fahrradbranche steht MAGURA für höchste Zuverlässigkeit und Qualität. Viele der MAGURA Komponenten sind nach wie vor „Made in Germany“: sie werden unweit vom Hauptsitz in Bad Urach in zwei Werken auf der schwäbischen Alb hergestellt. Dazu gehören unter anderem die Bremsgriffe aus den eigens entwickelten Werkstoffen Carbotechture® und Carbotechture SL®. Carbotechture SL® besteht aus einem mit Carbonfasern verstärktem High-Tech Polymer, das extrem stoß- und reißfest ist, über eine hohe Elastizität verfügt und dadurch äußerst robust ist. Carbotechture® verfügt über ähnliche Eigenschaften – allerdings kommen dort statt Carbonfasern Fiberglasfasern zum Einsatz.

Durch den Einsatz unserer selbst entwickelten High-Tech Kunststoffe Carbotechture SL®, Carbotechture® und dem Herstellungsverfahren Carbolay lassen sich sehr leichte, aber widerstandsfähige Komponenten herstellen. Dass diese Werkstoffe für höchste Ansprüche geschaffen sind zeigt nicht zuletzt auch deren Verwendung für Brems- und Kupplungsarmaturen bei Motorrädern.

## MAGURA technology – materials

MAGURA stands for the highest reliability and quality in both the motorcycle and bicycle industries. Many of the MAGURA components are “Made in Germany”, produced not far from the headquarters in Bad Urach in two factories on the Swabian Alb. These components include the brake masters made of our own developed materials Carbotechture SL® and Carbotechture®. Carbotechture SL® consists of a carbon fibre-reinforced, high-tech polymer, a material that is extremely impact and tear resistant and has a high degree of elasticity, making it extremely robust. Carbotechture® has similar properties, but fibreglass fibres are used instead of carbon fibres.

Very light but extremely resistant components can be produced thanks to our high-tech plastics Carbotechture SL®, Carbotechture® and the Carbolay manufacturing process, all developed in-house by MAGURA. The fact that these materials have been created for the highest demands is demonstrated not least by their use for brake and clutch valves on motorcycles.



# CUTTING-EDGE MATERIALS

## CARBOTECTURE®

- Kunststoffgranulat aus Hightech-Polymeren und kurzen Carbon- bzw. Glasfasern
- Jede gewünschte Form durch das Carboflow Verfahren möglich
- Komplexe Formen mit glatter Oberfläche realisierbar
- 50 % leichter als Aluminium bei identischer Zug- und Bruchfestigkeit

## CARBOTECTURE SL®

- Weiterentwicklung von Carbotecture®
- Einbindung mittellanger Carbonfasern
- Zusätzliche Gewichtsreduzierung bei nochmals erhöhter Widerstandsfähigkeit

## CARBOLAY® VERFAHREN

- Belastungsgerechte Positionierung von Carbonfasern über ein textiles Legeverfahren
- Vollautomatische Fertigung ohne Carbonübliche Handarbeit
- Hohe Steifigkeit der Komponenten bei gleichzeitig geringem Gewicht

## CARBOTECTURE®

- Synthetic granules made of high-tech polymers and short carbon or glass fibres
- Any desired shape can be achieved thanks to the Carboflow process
- Complex shapes with smooth surfaces can be created
- 50 % lighter than aluminium, with identical tensile and breaking strength

## CARBOTECTURE SL®

- An enhanced development of Carbotecture®
- Integration of medium-length carbon fibres
- Additional weight reduction with a level of resistance that has been increased yet again

## CARBOLAY® PROCESS

- Load-appropriate positioning of carbon fibres using a textile process
- Fully-automatic production without the usual manual work associated with carbon
- High rigidity of the components combined with low weight

# PRODUKTÜBERSICHT SCHEIBENBREMSEN 2022

PRO

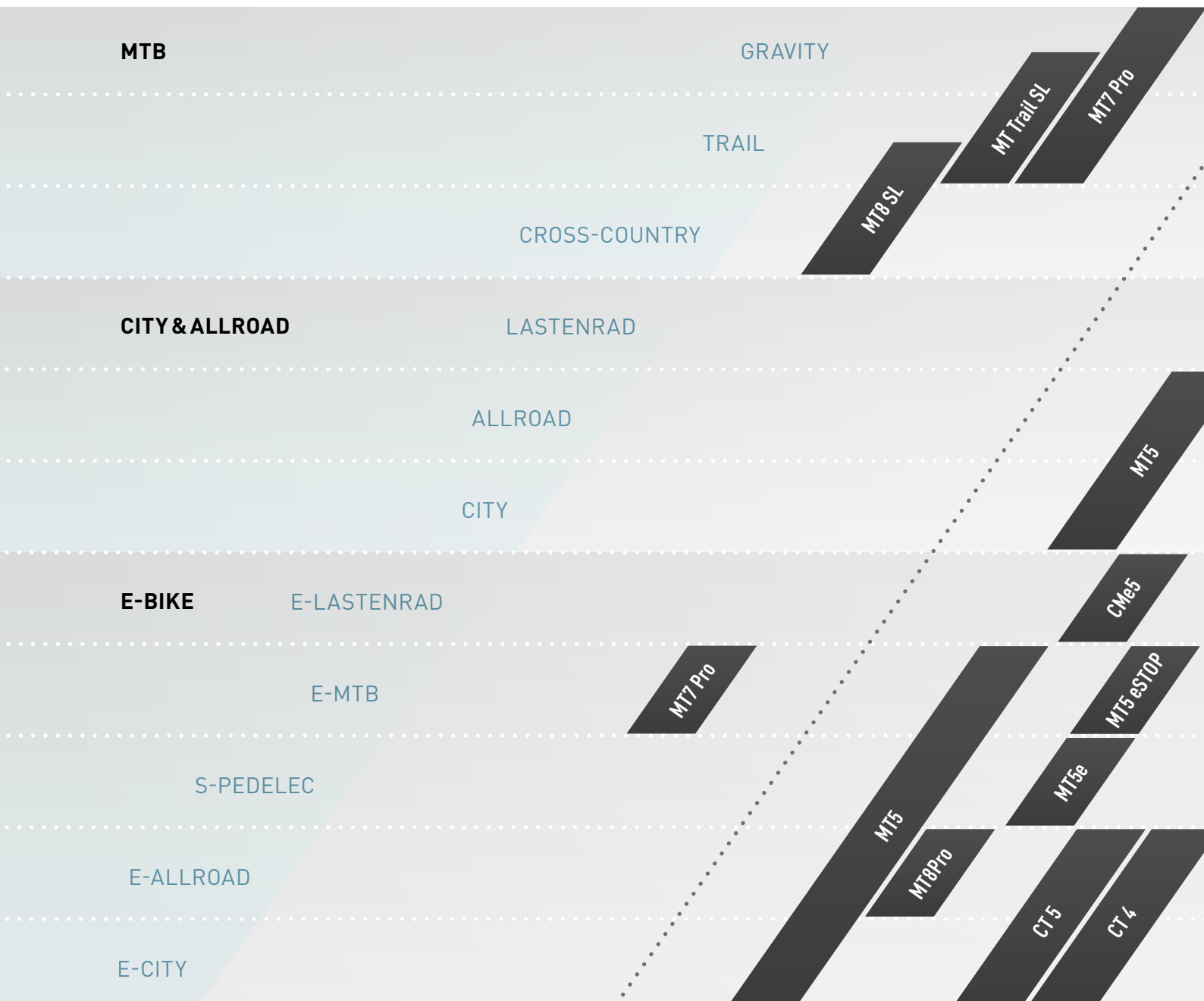

## MAGURA Produktübersicht 2022

MAGURA bietet für jedes Fahrrad und jeden Fahrstil die idealen Komponenten – ganz egal, ob Scheibenbremse, Felgenbremse oder verstellbare Sattelstütze. Bei den Themen Fahrsicherheit, Komfort und innovative E-Lösungen besitzt MAGURA ein umfassendes und stetig wachsendes Produktportfolio.

Die Grafik hilft bei der Auswahl des passenden Produkts. Eine Sortierung nach Einsatzbereich (horizontal) und Anspruch (vertikal) bietet einen einfachen Überblick über die gesamte Produktpalette.

Erklärung zu Produktbezeichnungen:  
SL = 1-Finger HC Carbon Hebel  
PRO = 1-Finger HC Aluminium Hebel

## MAGURA Product Overview 2022

MAGURA offers the ideal components for every bike and every riding style, whether it's disc brakes, rim brakes or dropper seatposts. The company has a comprehensive and constantly-growing product portfolio covering riding safety, comfort and innovative e-solutions.

The graphic will help you select the right product. Graded by usage (horizontal) and requirement (vertical) providing a simple overview of the entire product range.

Explanation of product designations:  
SL = 1-finger HC Carbon lever blade  
PRO = 1-finger HC Aluminium lever blade



## ADVANCED

## BASIC

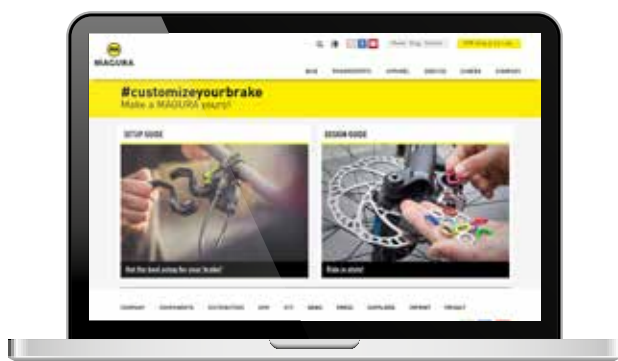
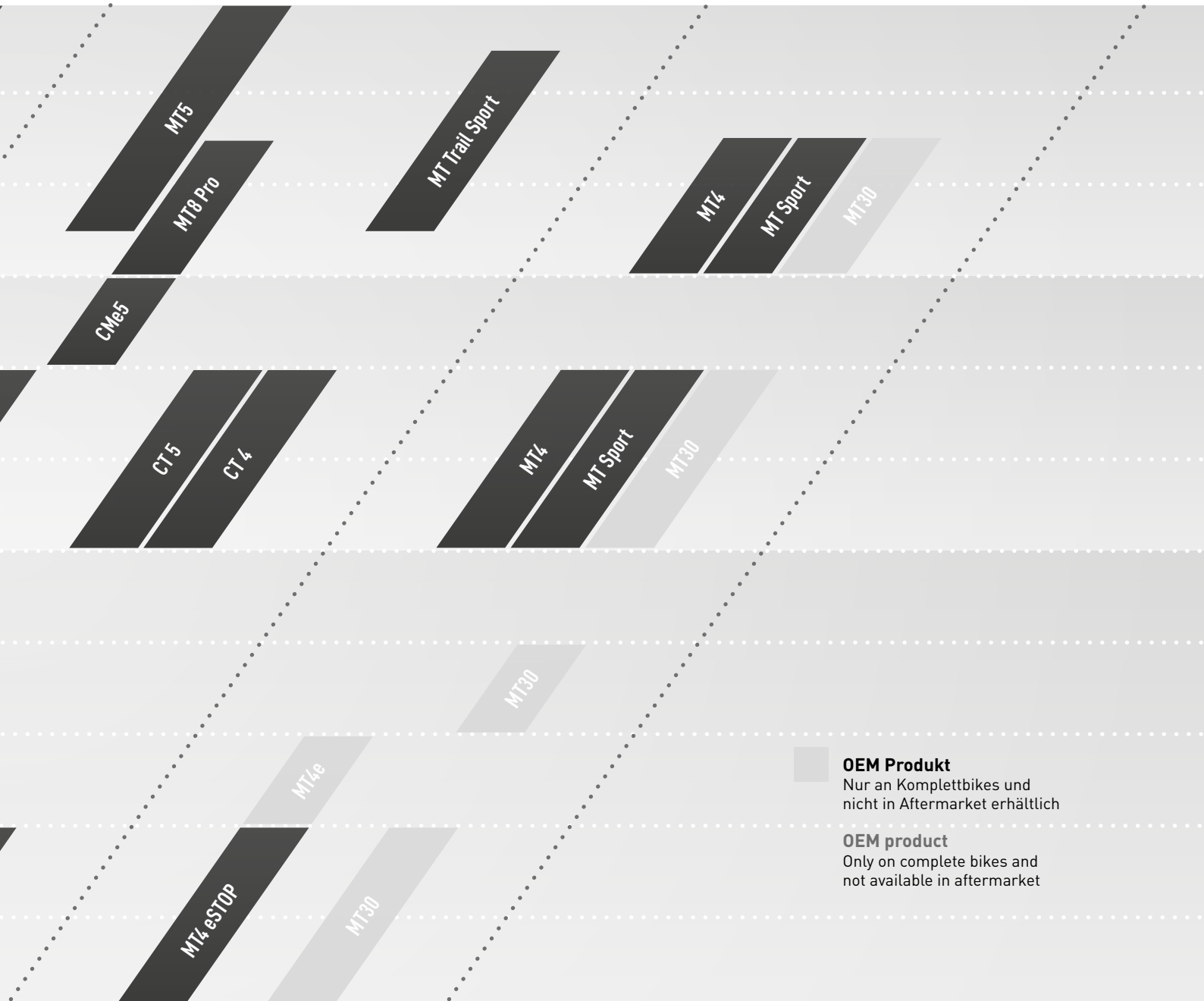

Für eine interaktive Kaufberatung steht der Buyers Guide online zur Verfügung unter: [www.magura.com/customize](http://www.magura.com/customize).

The Buyers Guide for interactive buying advice is available online at [www.magura.com/customize](http://www.magura.com/customize).





# DISC BRAKES

# DISC BRAKES MT TECHNOLOGY



.....

**1 EASY BLEED TECHNOLOGY**  
Schnelles und einfaches Entlüften  
Quick and easy bleeding

.....

**2 TOOLLESS REACH ADJUSTMENT**  
Werkzeuglose Hebelweitenverstellung  
Toolless reach adjust

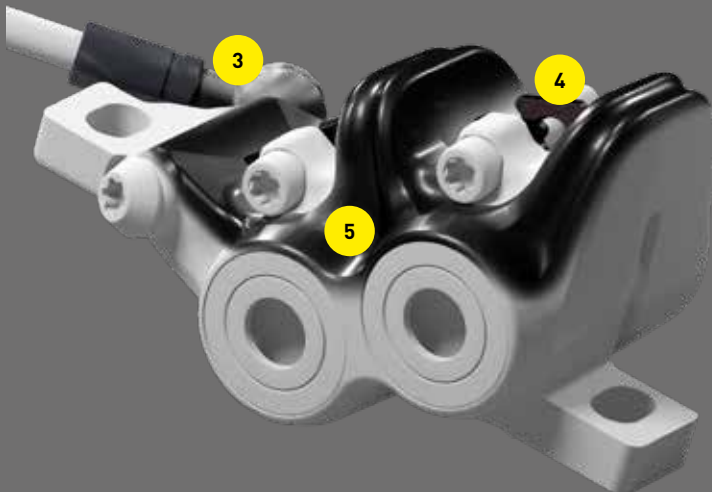
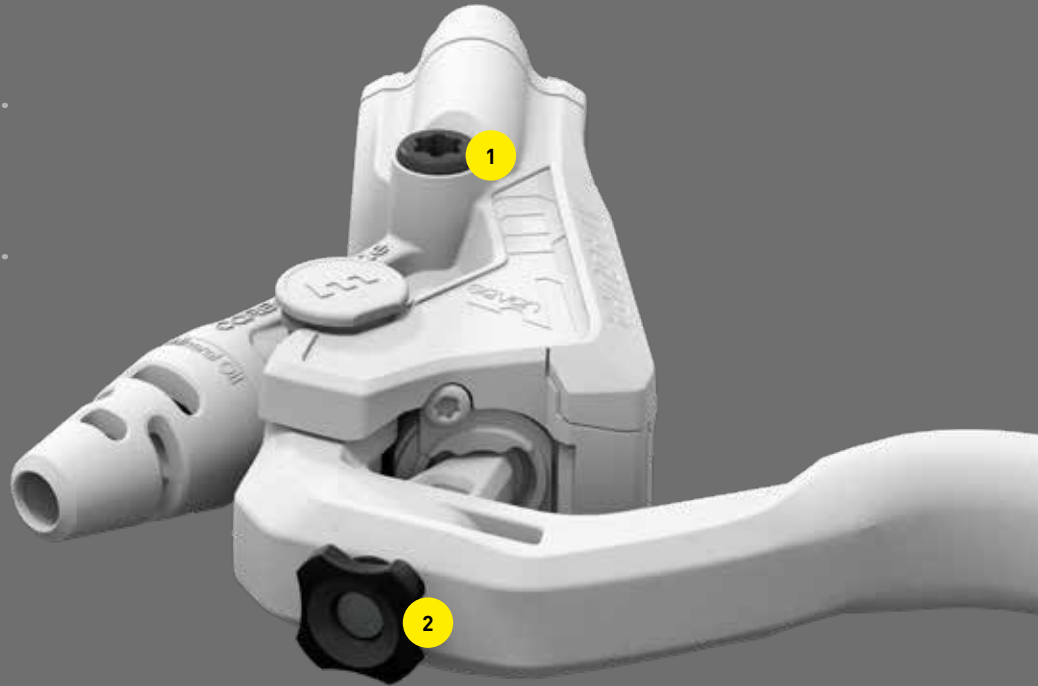

.....

**3 BANJO FITTING**  
Drehbarer Leitungsanschluss  
Rotatable tubing routing

.....

**4 MAGNETIXCHANGE**  
Einfacher Belagswechsel  
Easy brake pad replacement

.....

**5 TRIPLE ARCH DESIGN**  
Optimale Steifigkeit des Bremssattels  
Ultimate caliper rigidity

 **DESIGNED AND  
ENGINEERED IN GERMANY**

**5 YEARS LEAK  
PROOF GUARANTEE**

 **FILLED WITH  
ROYAL BLOOD**

# MT7 PRO

Der klar definierte Druckpunkt und maximale Power machen sie zur ersten Wahl von Gravity- und High-Speed-Piloten. Der 1-Finger HC Bremshebel moduliert die enorme Bremspower ganz nach Wunsch.

The clearly defined bite point and maximum power make it the first choice for gravity and high-speed pilots. The 1-finger HC lever blade modulates the enormous braking power as desired.

Gewicht Weight	255 g
Bremsgriff Master	Carbotecture SL®
Bremshebel Lever blade	1-Finger HC, Hollow Aluminium
Hebelweitenverstellung Reach adjust	werkzeuglos toolless
Kolben Pistons	4
UVP RRP	219,90 €*
Artikel-Nr. Order No.	2 702 431



E-BIKE READY

AWARD-WINNING BRAKING PERFORMANCE  
ADAPTABLE ERGONOMICS  
WEIGHT RATIO PERFORMANCE



BEST IN TEST  
E BRAKES GROUP TEST



E-MOUNTAINBIKE MAGAZIN  
TEST SIEGER  
03/2018



# MT5

Volle Gravity-Bremspower der 4 Kolben als erschwinglicher Einstieg. Alle Gene der MT7 stecken in unserem Modell MT5 für den Downhill- und Enduro-Einsatz. Zuverlässig und stark – auch für E-Bikes.

Full gravity braking power of the 4 pistons as an affordable entry level. Our MT5 downhill and enduro model has all the genes of the MT7. Reliable and strong – also for e-bikes.

Gewicht Weight	255 g*
Bremsgriff Master	Carbotecture®
Bremshebel Lever blade	2-Finger, Aluminium
Hebelweitenverstellung Reach adjust	Torx T25 T25 tool
Kolben Pistons	4
UVP RRP	109,90 €*
Artikel-Nr. Order No.	2 700 477



E-BIKE READY

GENES OF THE MT7  
ENTRY-LEVEL 4 PISTONS BRAKING POWER  
HIGH-QUALITY MATERIALS



BEST IN TEST  
E BRAKES GROUP TEST

BEST VALUE  
E BRAKES GROUP TEST

bike 3/2016  
MAGURA M5  
T25 SCHLÜSSEL  
T25 SCHLÜSSEL

FREE-RIDE  
Bremsentest 02/2016  
Freeride-Ranking:  
10/10 Punkte



Alle Preise inkl. MwSt. All prices including VAT.

\* 800 mm Leitungslänge ohne Bremsscheibe/Adapter 800 mm brake tubing length without rotor/adapter

# DISC BRAKES

## MT TRAIL SL

MAGURAs Definition von Trail-Bremsperformance – 4 Kolben vorne für höchste Bremspower, 2 Kolben hinten für perfekte Dosierbarkeit. Dank des 1-Finger HC Carbon Hebels mit nur rund 230 Gramm (Mittelwert).

MAGURA's definition of trail braking performance – 4 pistons in the front for maximum braking power, 2 pistons in the rear for perfect modulation. Thanks to the 1-finger HC Carbon lever blade it just weigh around about 230 g (average value).

Gewicht (V/H) Weight (F/R)	240 g / 220 g
Bremsgriff Master	Carbotecture SL®
Bremshebel Lever blade	1-Finger HC, Carbon
Hebelweitenverstellung Reach adjust	Inbus SW3 3 mm allen key
Kolben Pistons	4/2
UVP RRP	579,90 € (Set)*
Artikel-Nr. Order No.	2 701 646



E-BIKE READY

100% TRAIL PERFORMANCE

LIGHTWEIGHT

1-FINGER HC CARBON LEVER BLADE



## MT TRAIL SPORT

100% Trail Performance zu einem attraktiven Preis. Fast so bissig und leicht wie ihre große Schwester – und gleichzeitig genauso gefühlvoll. Der MAGURA Einstieg in das 4/2-Bremskolben-Konzept.

100% trail performance at an attractive price. Almost as snappy and light as its big sister – and just as sensitive too. This is the MAGURA entry into the 4/2 brake piston concept.

Gewicht (V/H) Weight (F/R)	255 g / 230 g
Bremsgriff Master	Carbotecture®
Bremshebel Lever blade	1-Finger HC, Hollow Aluminium
Hebelweitenverstellung Reach adjust	Inbus SW3 3 mm allen key
Kolben Pistons	4/2
UVP RRP	219,90 € (Set)*
Artikel-Nr. Order No.	2 701 389



E-BIKE READY

GENES OF THE MT TRAIL SL

1-FINGER HC LEVER BLADE

ENTRY-LEVEL TRAIL BRAKING POWER



Alle Preise inkl. MwSt. All prices including VAT.

\* 800 mm Leitungslänge ohne Bremsscheibe/Adapter 800 mm brake tubing length without rotor/adapter



Photo: Philip Ruopp

# DISC BRAKES

## MT8 SL

Perfekt für Cross Country und Marathon Wettkämpfe: Super leicht durch das Carbotecture SL® Gehäuse und eine hohe Bremskraft dank des ergonomischen 1-Finger HC Carbon Bremshebel. Darauf vertrauen die Profis. Perfect for cross country and marathon competitions: super light due to the Carbotecture SL® housing and with high braking power thanks to the ergonomic 1-finger HC Carbon lever blade. All reasons professional races trust in this brake.

Gewicht Weight	195 g
Bremsgriff Master	Carbotecture SL®
Bremshebel Lever blade	1-Finger HC, Carbon
Hebelweitenverstellung Reach adjust	Inbus SW3 3 mm allen key
Kolben Pistons	2
UVP RRP	279,90 €*
Artikel-Nr. Order No.	2 701 657



E-BIKE READY

ENGINEERED FOR RACING  
1-FINGER HC CARBON LEVER BLADE  
LIGHTWEIGHT PERFORMANCE



## MT8 PRO

Die MT8 Pro bietet die gleiche Performance wie das High-End Modell MT8 SL zu einem attraktiven Preis. Ausgestattet mit 1-Finger HC Hebel aus Aluminium bietet sie Zuverlässigkeit auf Touren und im Wettkampf. The MT8 Pro offers the same performance as the high-end MT8 SL model at an attractive price. Equipped with a 1-finger HC aluminium lever blade it provides reliability on tours and in competition.

Gewicht Weight	225 g
Bremsgriff Master	Carbotecture SL®
Bremshebel Lever blade	1-Finger HC, Hollow Aluminium
Hebelweitenverstellung Reach adjust	werkzeuglos toolless
Kolben Pistons	2
UVP RRP	179,90 €*
Artikel-Nr. Order No.	2 701 728



E-BIKE READY

GENES OF THE MT8 SL  
ELEGANT CHROME POLISHED FINISH  
LIGHTWEIGHT TECHNOLOGY



## MT4

Der perfekte Allrounder für Mountainbiker, die auf Standfestigkeit und Bremspower setzen, ohne Kompromisse beim Gewicht. Der Carbotecture®-Bremsgriff hält das Gesamtgewicht bei nur 230 Gramm.

The perfect all-rounder for mountain bikers who value stability and braking power, without having to compromise on weight. The Carbotecture® master keeps the entire weight to 230 grams.

Gewicht Weight	230 g
Bremsgriff Master	Carbotecture®
Bremshebel Lever blade	2-Finger, Aluminium
Hebelweitenverstellung Reach adjust	Torx T25 T25 tool
Kolben Pistons	2
UVP RRP	89,90 €* 89,90 €*
Artikel-Nr. Order No.	2 700 476



E-BIKE READY

**PERFECT ALL-ROUNDER**  
**VERY GOOD PRICE/PERFORMANCE RATIO**  
**INNOVATIVE TECHNOLOGY**

## MT SPORT

Der Einstieg in die MAGURA MT-Welt. Sie besitzt alle High-Tech-Features deutscher Ingenieurskunst, wie z. B. leichte Carbotecture® Komponenten und die bewährte MAGURA Discstube Leitung für sichere Stops auf Touren oder in der Stadt.

The entry level to the MAGURA MT world. With all of the high-tech features of german engineering skill, such as lightweight Carbotecture® components and the improved MAGURA discstube for safe stopping on tour and in the city.

Gewicht Weight	245 g
Bremsgriff Master	Carbotecture®
Bremshebel Lever blade	2-Finger, Carbotecture®
Hebelweitenverstellung Reach adjust	Torx T25 T25 tool
Kolben Pistons	2
UVP RRP	59,90 €* 59,90 €*
Artikel-Nr. Order No.	2 701 705



E-BIKE READY

**JOIN THE MAGURA MT FAMILY**  
**FULL CARBOTECTURE® MASTER**  
**VERY GOOD PRICE/WEIGHT RATIO**



Alle Preise inkl. MwSt. All prices including VAT.

\* 800 mm Leitungslänge ohne Bremsscheibe/Adapter 800 mm brake tubing length without rotor/adapter

# DISC BRAKES FLATMOUNT TECHNOLOGY



.....

## 1 MAGNETIXCHANGE

Einfacher Belagswechsel  
Easy brake pad replacement

.....

## 2 FLATMOUNT MOUNTING

Zange mit Gewinde (M5), einfacher Anbau  
Caliper with threads (M5), easy mounting

.....

## 3 STANDARD 2 PISTONS MT BRAKE PADS

Hohe Bremsleistung und Standfestigkeit  
High braking performance and stability

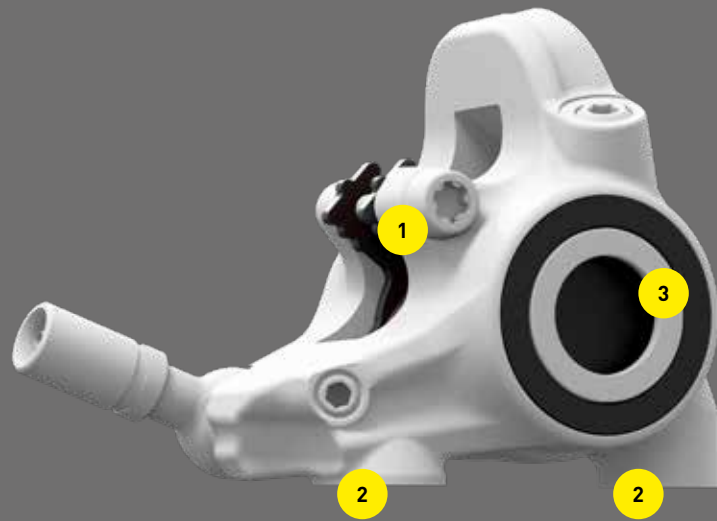

### Flatmount Bremsen

Bei der Flatmount Bremse befinden sich die Gewinde in der Zange und werden mit M5 Schrauben befestigt. Das kompakte Design und integrierte Gewinde erleichtern den Anbau auf der Kettenstrebe. Durch die gleiche Belags- und Kolbengröße der Standard 2 Kolben MT Bremse ist die Flatmount Bremse genauso standhaft wie die Postmount Variante.

### Flatmount brakes

The flatmount brake is characterized by integrated threads in the caliper, which are fastened with M5 screws. The compact design and integrated threads simplify the mounting on the chain stay. Due to the same brake pad and pistons size of the standard 2 pistons MT brake, the flatmount brake is just as strong as the postmount variant.

 **DESIGNED AND  
ENGINEERED IN GERMANY**

**5** YEARS LEAK  
PROOF GUARANTEE

 **FILLED WITH  
ROYAL BLOOD**

## MT8 SL FLATMOUNT

Unsere MT8 SL FM bremst ambitionierte Cross-Country-Racer erst, wenn sie es wollen – im letzten Moment. Maximal 160 mm Bremsscheiben packt die MT8 SL FM und zeigt sich dadurch so kräftig und verschleißarm wie ihr Vorbild MT8 SL.

With the MT8 SL FM, ambitious cross-country racers can brake right when they want to – at the last moment. The MT8 SL FM accommodates brake discs up to 160 mm, making it just as powerful and wear-resistant as the MT8 SL, on which it is based.

Gewicht Weight	185 g
Bremsgriff Master	Carbotecture SL®
Bremshebel Lever blade	1-Finger HC, Carbon
Hebelweitenverstellung Reach adjust	Inbus SW3 3 mm allen key
Kolben Pistons	2
UVP RRP	279,90 €* 279,90 €*
Artikel-Nr. Order No.	2 701 632



## MT4 FLATMOUNT

Elegant, schlank und dabei ganz schön bissig. Trotz ihrer kompakten Größe nimmt die MT4 FM unsere Standard-Bremsbeläge auf, so dass sie genauso leistungsfähig und hitzeresistent wie unsere „großen“ Modelle ist.

Elegant and slim, but with a powerful bite. Although it has a more compact design, the MT4 FM takes our standard brake pads, so it is just as powerful and heat resistant as our "large" models.

Gewicht Weight	220 g
Bremsgriff Master	Carbotecture®
Bremshebel Lever blade	2-Finger, Aluminium
Hebelweitenverstellung Reach adjust	Torx T25 T25 tool
Kolben Pistons	2
UVP RRP	129,90 €* 129,90 €*
Artikel-Nr. Order No.	2 701 633



Alle Preise inkl. MwSt. All prices including VAT.

\* 800 mm Leitungslänge ohne Bremsscheibe/Adapter 800 mm brake tubing length without rotor/adaptor

# DISC BRAKES E-BIKE OPTIMIZED TECHNOLOGY



## MT eSTOP BREMSSEN

Die Komponenten unseres MT eSTOP Bremssystems sind perfekt aufeinander abgestimmt. Dadurch bieten sie maximale Performance, die für den Einsatz am E-Bike aufgrund höherer Massen und Geschwindigkeiten extrem wichtig ist.

Das System besteht aus 3 Komponenten – für beste Performance und Sicherheit!

## MT eSTOP BRAKES

Because the components used to make the MT eSTOP brake system are perfectly matched to each other they can offer the maximum performance needed for an e-bike due to the higher mass and speeds.

The system consists of 3 components – for best performance and security!

### 1 MT eSTOP BRAKES

Besitzen alle Eigenschaften unserer bewährten MT Serie

Have all the features of our proven MT series

Als 2- oder 4-Kolben Variante verfügbar

Available as 2- or 4-pistons version

### 2 MDR-C AND MDR-P ROTORS

Bessere Wärmeableitung und längere Standfestigkeit

Better heat resistance and greater stability

MDR-P bis 220 mm verfügbar

MDR-P available up to 220 mm

### 3 SPORT BRAKE PADS

Neue Belagsmischung mit verkürzter Einbremsdauer

New brake pad compound with shorter bed-in time

Längere Haltbarkeit

Longer durability



# 3 PARTS — ONE PERFECT SYSTEM

## MT5 eSTOP

Das Topmodell von MAGURA für den anspruchsvollen E-Bike Einsatz. Mit kraftvollen 4-Kolben Bremszangen bietet die MT5 eSTOP auch an schweren E-Bikes sichere Performance bei hohen Geschwindigkeiten.

This is MAGURA's top model for more demanding e-bike use. With its powerful 4-pistons calipers, the MT5 eSTOP offers safe performance at high speeds, even on heavy e-bikes.

Gewicht Weight	255 g
Bremsgriff Master	Carbotecture®
Bremshebel Lever blade	2-Finger, Aluminium
Hebelweitenverstellung Reach adjust	Torx T25 T25 tool
Kolben Pistons	4
UVP RRP	114,90 €
Artikel-Nr. Order No.	2 701 999
Empfohlene Bremsscheibe Recommended rotor	MDR-P



**FLAGSHIP FOR E-BIKES**  
**HIGH STABILITY & POWER**  
**LONGER DURABILITY**

## MT4 eSTOP

Optimiert für die Anforderungen moderner E-Bikes. Sichere Power für Touren im Gelände oder in der Stadt. Dank optimierter Komponenten besonders sorglos.

Optimized for the requirements of modern e-bikes. Controlled power for off-road and city tours. Particularly reliable thanks to optimized components.

Gewicht Weight	230 g
Bremsgriff Master	Carbotecture®
Bremshebel Lever blade	2-Finger, Aluminium
Hebelweitenverstellung Reach adjust	Torx T25 T25 tool
Kolben Pistons	2
UVP RRP	94,90 €
Artikel-Nr. Order No.	2 702 000
Empfohlene Bremsscheibe Recommended rotor	MDR-C



**PERFECT E-BIKE ALLROUNDER**  
**LONGER DURABILITY**  
**HIGH QUALITY MATERIALS**

Alle Preise inkl. MwSt. All prices including VAT.

\* 800 mm Leitungslänge ohne Bremsscheibe/Adapter 800 mm brake tubing length without rotor/adaptor

# DISC BRAKES

## E-BIKE OPTIMIZED KIT



### MT eSTOP OPTIMIZED KIT FÜR E-MTB MT eSTOP OPTIMIZED KIT FOR E-MTB

	Artikelnummer 6-Loch Order Number 6 hole	UVP RRP
MT eSTOP Optimized Kit 180/P - 8.S: Bremsscheibe MDR-P, Ø 180 mm, 6-Loch/Center-Lock und Bremsbelag 8.S, SPORT (VE = 1 Set) MT eSTOP Optimized Kit 180/P - 8.S: Rotor MDR-P, Ø 180 mm, 6 hole/ Center-Lock and brake pads 8.S, SPORT (PU = 1 set)	2 702 440	69,50 €
MT eSTOP Optimized Kit 203/P - 8.S: Bremsscheibe MDR-P, Ø 203 mm, 6-Loch/Center-Lock und Bremsbelag 8.S, SPORT (VE = 1 Set) MT eSTOP Optimized Kit 203/P - 8.S: Rotor MDR-P, Ø 203 mm, 6 hole/ Center-Lock and brake pads 8.S, SPORT (PU = 1 set)	2 702 028	69,50 €
MT eSTOP Optimized Kit 220/P - 8.S: Bremsscheibe MDR-P, Ø 220 mm, 6-Loch und Bremsbelag 8.S, SPORT (VE = 1 Set) MT eSTOP Optimized Kit 220/P - 8.S: Rotor MDR-P, Ø 220 mm, 6 hole and brake pads 8.S, SPORT (PU = 1 set)	2 702 029	69,50 €
MT eSTOP Optimized Kit 180/P - 7.S: Bremsscheibe MDR-P, Ø 180 mm, 6-Loch/Center-Lock und Bremsbelag 7.S, SPORT (VE = 1 Set) MT eSTOP Optimized Kit 180/P - 7.S: Rotor MDR-P, Ø 180 mm, 6 hole/ Center-Lock and brake pads 7.S, SPORT (PU = 1 set) (PU = 1 set)	2 702 441	66,50 €
MT eSTOP Optimized Kit 203/P - 7.S: Bremsscheibe MDR-P, Ø 203 mm, 6-Loch/Center-Lock und Bremsbelag 7.S, SPORT (VE = 1 Set) MT eSTOP Optimized Kit 203/P - 7.S: Rotor MDR-P, Ø 203 mm, 6 hole/ Center-Lock and brake pads 7.S, SPORT (PU = 1 set)	2 702 030	66,50 €
MT eSTOP Optimized Kit 220/P - 7.S: Bremsscheibe MDR-P, Ø 220 mm, 6-Loch und Bremsbelag 7.S, SPORT (VE = 1 Set) MT eSTOP Optimized Kit 220/P - 7.S: Rotor MDR-P, Ø 220 mm, 6 hole and brake pads 7.S, SPORT (PU = 1 set)	2 702 031	66,50 €

### MT eSTOP OPTIMIZED KIT FÜR E-CITY / E-TREKKING MT eSTOP OPTIMIZED KIT FOR E-CITY / E-TREKKING

	Artikelnummer Order Number	UVP RRP
MT eSTOP Optimized Kit 160/C - 8.S: Bremsscheibe MDR-C, Ø 160 mm, 6-Loch und Bremsbelag 8.S, SPORT (VE = 1 Set) MT eSTOP Optimized Kit 160/C - 8.S: Rotor MDR-C, Ø 160 mm, 6 hole and brake pads 8.S, SPORT (PU = 1 set)	2 702 445	45,50 €
MT eSTOP Optimized Kit 180/C - 8.S: Bremsscheibe MDR-C, Ø 180 mm, 6-Loch und Bremsbelag 8.S, SPORT (VE = 1 Set) MT eSTOP Optimized Kit 180/C - 8.S: Rotor MDR-C, Ø 180 mm, 6 hole and brake pads 8.S, SPORT (PU = 1 set)	2 70 2018	45,50 €
MT eSTOP Optimized Kit 203/C - 8.S: Bremsscheibe MDR-C, Ø 203 mm, 6-Loch und Bremsbelag 8.S, SPORT (VE = 1 Set) MT eSTOP Optimized Kit 203/C - 8.S: Rotor MDR-C, Ø 203 mm, 6 hole and brake pads 8.S, SPORT (PU = 1 set)	2 702 025	45,50 €
MT eSTOP Optimized Kit 160/C - 7.S: Bremsscheibe MDR-C, Ø 160 mm, 6-Loch und Bremsbelag 7.S, SPORT (VE = 1 Set) MT eSTOP Optimized Kit 160/C - 7.S: Rotor MDR-C, Ø 160 mm, 6 hole and brake pads 7.S, SPORT (PU = 1 set)	2 702 446	44,00 €
MT eSTOP Optimized Kit 180/C - 7.S: Bremsscheibe MDR-C, Ø 180 mm, 6-Loch und Bremsbelag 7.S, SPORT (VE = 1 Set) MT eSTOP Optimized Kit 180/C - 7.S: Rotor MDR-C, Ø 180 mm, 6 hole and brake pads 7.S, SPORT (PU = 1 set)	2 702 026	44,00 €
MT eSTOP Optimized Kit 203/C - 7.S: Bremsscheibe MDR-C, Ø 203 mm, 6-Loch und Bremsbelag 7.S, SPORT (VE = 1 Set) MT eSTOP Optimized Kit 203/C - 7.S: Rotor MDR-C, Ø 203 mm, 6 hole and brake pads 7.S, SPORT (PU = 1 set)	2 702 027	44,00 €



Photo: Philip Ruyter

# DISC BRAKES CT TECHNOLOGY



Die CT ist MAGURA's neue Scheibenbremse für höchste Sicherheit, Sorglosigkeit und Bremskomfort. Optimiert für City & Trekking, Allroad und leichten MTB-Einsatz. Speziell optimiert für E-Bikes aber auch an normalen Bikes eine gute Wahl!

The CT is MAGURA's new disc brake for maximum safety, carefree and comfortable braking. Optimized for City & Trekking, Allroad and light MTB use. Specially optimized for E-bikes but also on normal bikes a good choice!

.....

### 1 LARGE OIL RESERVOIR

Besonders wartungsarm  
Particularly low maintenance

.....

### 2 ERGONOMIC DESIGN

Ergonomische & wechselbare  
Bremshebel  
Ergonomic & changeable brake levers

.....

### 3 CARBOTECTURE TECHNOLOGY

Bruchfeste Materialien  
Break resistant materials

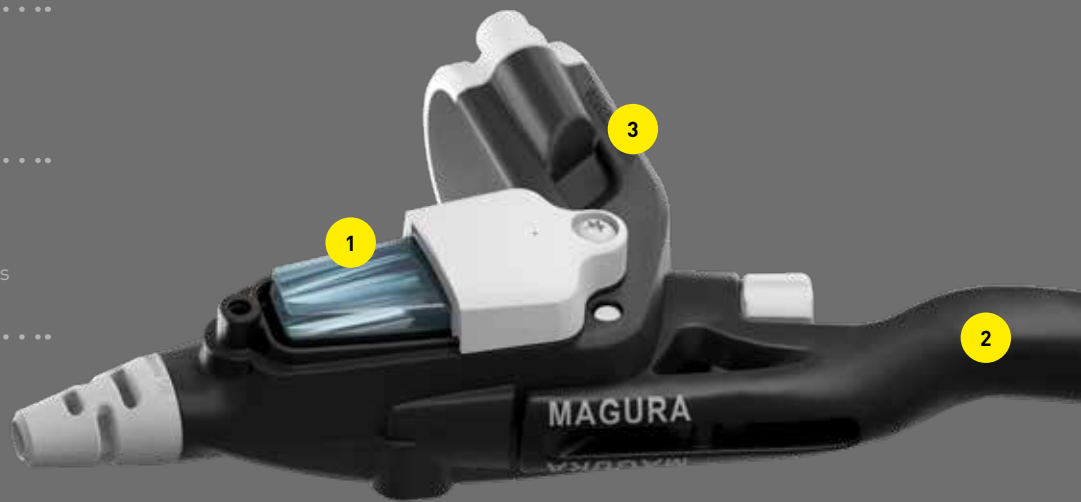

.....

### 4 SPORT BRAKE PADS

Besonders langlebig und leise  
Particularly durable and quiet

.....

### 5 TRIPLE ARCH DESIGN

Optimale Steifigkeit des Bremssattels  
Optimal stiffness of the brake caliper

.....

### 6 PROVEN MT CALIPERS

Bewährte Power und Hitzestabilität  
als 2- oder 4-Kolben Variante  
Proven power and heat stability  
as 2- or 4-piston variant

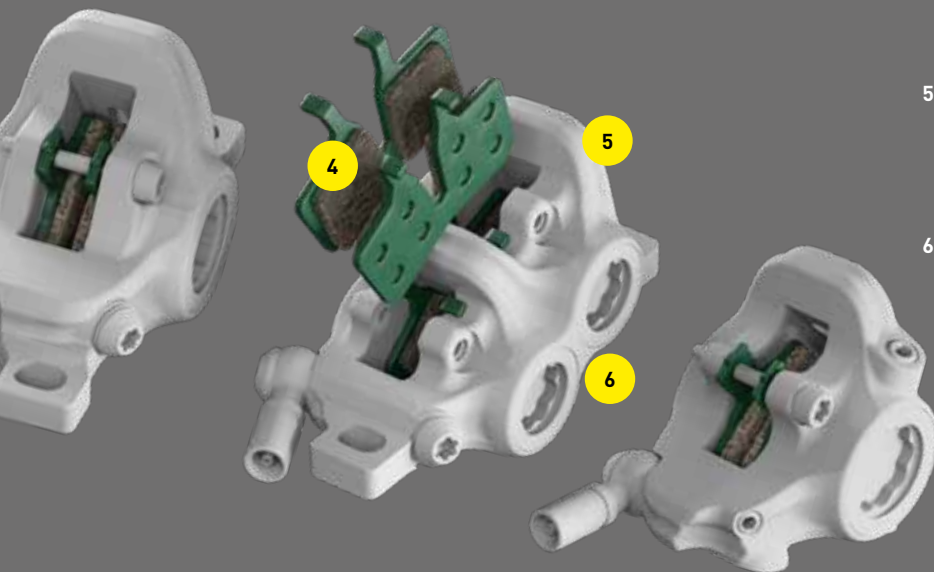

 **DESIGNED AND  
ENGINEERED IN GERMANY**

**5 YEARS LEAK  
PROOF GUARANTEE**

 **FILLED WITH  
ROYAL BLOOD**



# CT5

Volle Bremspower, Komfort und geringer Wartungsbedarf für die Stadt bis hin zu leichtem MTB Einsatz. Die CT5 besitzt alle Gene der bewährten MT5 und ergänzt sie mit Features für besondere Sorglosigkeit und Komfort im urbanen Einsatz!

Full braking power, comfort and low maintenance requirements for the city to light MTB use. The CT5 has all the genes of the proven MT5 and complements them with Features for special carelessness and comfort in the urban use!

Gewicht Weight	295 Gramm
Bremsgriff Master	Carbotecture
Bremshebel Lever blade	3- Finger-Carbotecture
Hebelweitenverstellung Reach adjust	werkzeuglos toolless
Kolben Pistons	4
UVP RRP	169,90 €
Artikel-Nr. Order No.	2702542 (links left) 2702543 (rechts right)



**PROVEN MAGURA BRAKING POWER**  
**ESPECIALLY LOW MAINTENANCE**  
**ENHANCED BRAKING COMFORT**



Photo: Philip Ruopp

Alle Preise inkl. MwSt. All prices including VAT.

\* 800 mm Leitungslänge ohne Bremsscheibe/Adapter 800 mm brake tubing length without rotor/adaptor

# DISC BRAKES

## CT4

Der perfekte Allrounder für die Stadt und den Allroad Einsatz. Besonders sorglos und komfortabel dank neuem CT Geber mit großem Ausgleichsbehälter und optimierter Ergonomie.

The perfect all-rounder for city and all-road use. Particularly carefree and comfortable thanks to new CT sensor with large reservoir and optimized ergonomics.

Gewicht Weight	280 Gramm
Bremsgriff Master	Carbotecture
Bremshebel Lever blade	3- Finger-Carbotecture
Hebelweitenverstellung Reach adjust	werkzeuglos toolless
Kolben Pistons	2
UVP RRP	129,90 €
Artikel-Nr. Order No.	2702540 (links) 2702541 (rechts)



**PERFECT CITY ALLROUNDER**  
**ESPECIALLY LOW MAINTENANCE**  
**ENHANCED BRAKING COMFORT**

## CT4 FM

Die CT4 im schlanken und elegantem Design für Rahmen mit Flatmount Aufnahme. Trotz ihrer kompakten Größe nimmt sie unsere Standard Bremsbeläge auf, so dass sie genauso leistungsfähig und hitzeresistent wie unsere „großen“ Modelle ist.

The CT4 in a slim and elegant design for frame with flat-mount. Despite its compact size it takes our standard brake pads so that it is just as powerful and heat resistant as our "big" models.

Gewicht Weight	265 Gramm
Bremsgriff Master	Carbotecture
Bremshebel Lever blade	3- Finger-Carbotecture
Hebelweitenverstellung Reach adjust	werkzeuglos toolless
Kolben Pistons	2
UVP RRP	149,90 €
Artikel-Nr. Order No.	2702544 (links) 2702545 (rechts)



**COMPACT DESIGN**  
**STANDARD BRAKE PADS**  
**ESPECIALLY LOW MAINTENANCE**

Alle Preise inkl. MwSt. All prices including VAT.

\* 800 mm Leitungslänge ohne Bremsscheibe/Adapter 800 mm brake tubing length without rotor/adaptor







# RIM / BRAKES

# RIM BRAKES HS TECHNOLOGY



1 **BRAKE BOOSTER**

Brake Booster für definierteren Druckpunkt  
Brake booster for optimized bite point

2 **EASY PAD REPLACEMENT**

Einfacher Belagswechsel  
Easy brake pad replacement

3 **HS EASY MOUNT**

Einfache Montage und Anpassung  
Easy mounting and adjustment

4 **EV02**

Flexible Anpassung an alle Systeme  
Flexible adaptation to all systems

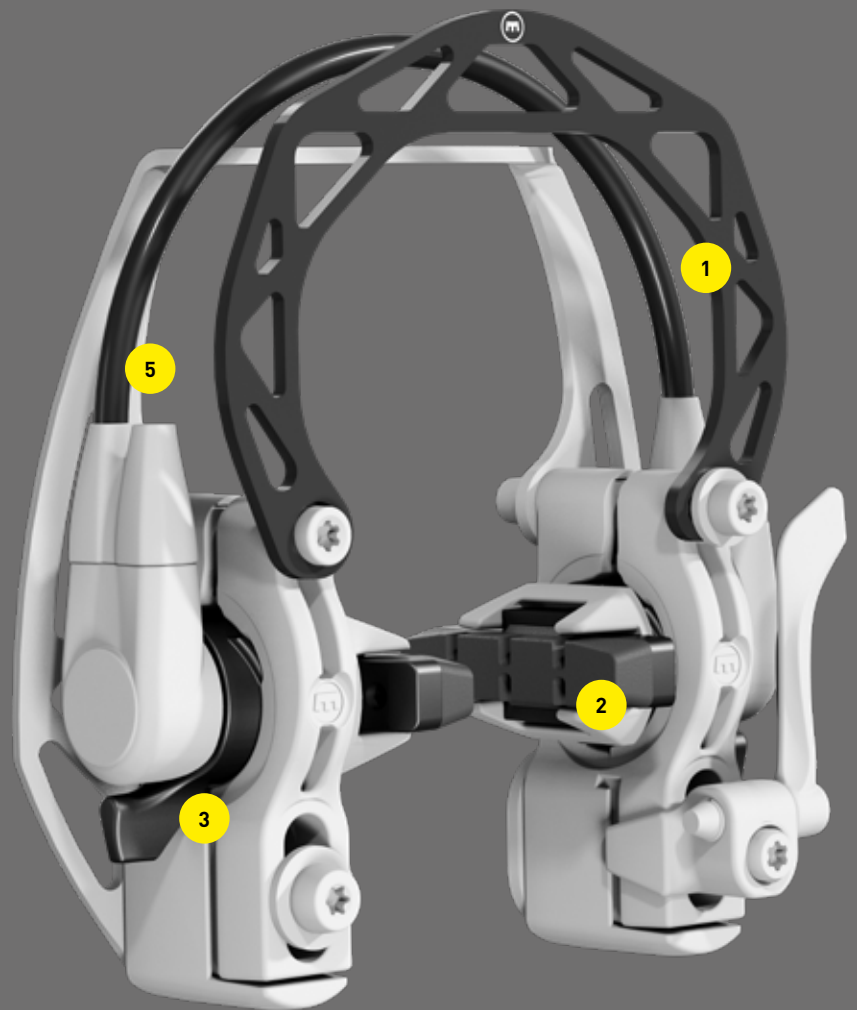

5 **MORE BRAKING POWER FOR E-BIKES**

Dank der optimierten Bremsleitung  
Thanks to optimized brake tubing

6 **EASY BLEED**

Schnelles und einfaches Entlüften  
Quick and easy bleeding

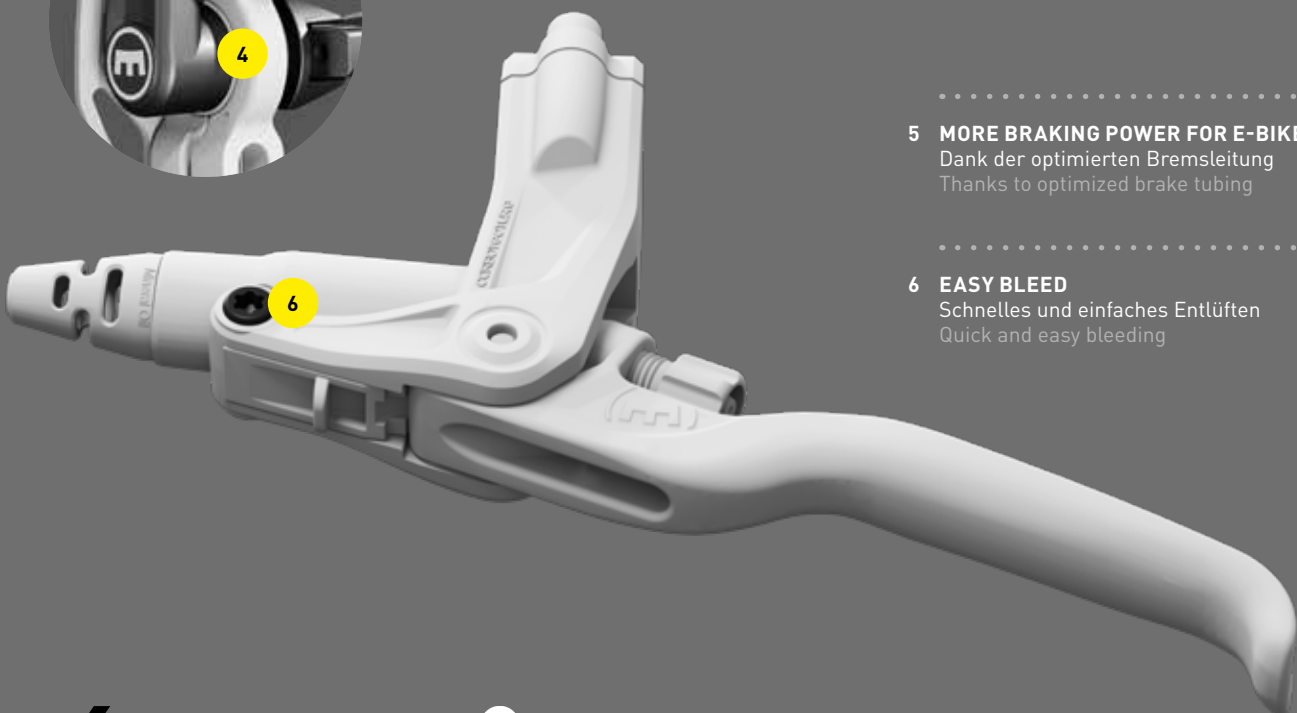

 **DESIGNED AND  
ENGINEERED IN GERMANY**

**5 YEARS LEAK  
PROOF GUARANTEE**

 **FILLED WITH  
ROYAL BLOOD**

# HS33

Unser unschlagbarer Klassiker. Das MAGURA Topmodell der Sorglos-Familie punktet mit Zuverlässigkeit und bietet erhöhte Bremskraft bei geringem Gewicht.

Our unbeatable classic. The MAGURA top model of the carefree family scores with sheer reliability and offers increased braking power and low weight.

Gewicht Weight	480 g
Bremsgriff Master	Carbotecture®
Bremshebel Lever blade	2-Finger, Aluminium opt.: 4-Finger, Aluminium
Hebelweitenverstellung Reach adjust	Torx T25 T25 tool
Belagverschleiß- nachstellung Pad wear adjustment	TPA
Anbau Mounting	Cantilever EVO2
UVP RRP	109,90 €
Artikel-Nr. Order No.	2 700 246 <sup>a</sup>

Mehr Farben: 2 700 246: schwarz, 2-Finger / 2 700 245: silber, 2-Finger / 2 700 247: schwarz, 4-Finger  
More colors: 2 700 246: black, 2-Finger / 2 700 245: silver, 2-Finger / 2 700 247: black, 4-Finger



E-BIKE READY

**SPORTY DESIGN**

**THE FLAGSHIP OF CAREFREE BRAKES**

**HUGE BRAKING POWER FOR RIM BRAKES**



Photo: Philip Ruopp

# RIM BRAKES

## HS22

An vielen Testsieger-Rädern verbaut, denn City- und Trekkingradler legen Wert auf Sicherheit und Wartungsfreiheit. Das Royal Blood kann ewig in den Leitungen bleiben. Fitted to many award-winning bicycles, because commuter and trekking riders value safety and maintenance-free features. The Royal Blood can remain in the brake tubing forever.

Gewicht Weight	480 g
Bremsgriff Master	Carbotecture®
Bremshebel Lever blade	3-Finger, Carbotecture®
Hebelweitenverstellung Reach adjust	werkzeuglos toolless
Belagverschleiß-nachstellung Pad wear adjustment	TPA
Anbau Mounting	Cantilever EV02, Easy Mount
UVP RRP	89,90 €
Artikel-Nr. Order No.	2 700 845 <sup>b</sup>



E-BIKE READY

**PROVEN ERGONOMICS**  
**ELEGANT DESIGN AND HIGH-QUALITY MATERIALS**  
**TOOLLESS BRAKE PAD ADJUSTMENT**

## HS11

Die Jüngste in der Familie ist genauso zuverlässig wie die Schwestern. Sie punktet mit hoher Bremskraft im Alltag und ist durch das ergonomische Bremshebel-design komfortabel.

The youngest in the family is just as reliable as its sisters, scoring with high braking power in everyday cycling. It's also comfortable, thanks to the ergonomic lever blade design.

Gewicht Weight	435 g
Bremsgriff Master	Carbotecture®
Bremshebel Lever blade	3-Finger, Carbotecture®
Hebelweitenverstellung Reach adjust	-
Belagverschleiß-nachstellung Pad wear adjustment	Torx T25 T25 tool
Anbau Mounting	Cantilever EV02, Easy Mount
UVP RRP	69,90 €
Artikel-Nr. Order No.	2 701 214 <sup>c</sup>



E-BIKE READY

**THE CAREFREE BRAKE**  
**ERGONOMIC AND STRONG**  
**PRECISE CONTROL**

Alle Preise inkl. MwSt. All prices including VAT.

<sup>b</sup> 2 700 845: 3-Finger, EV02 / 2 700 846: 3-Finger, Easy Mount <sup>b</sup> 2 700 845: 3-fingers, EV02 / 2 700 846: 3-fingers, Easy Mount  
<sup>c</sup> 2 701 214: 3-Finger, EV02 / 2 701 252: 3-Finger, Easy Mount <sup>c</sup> 2 701 214: 3-fingers, EV02 / 2 701 252: 3-fingers, Easy Mount



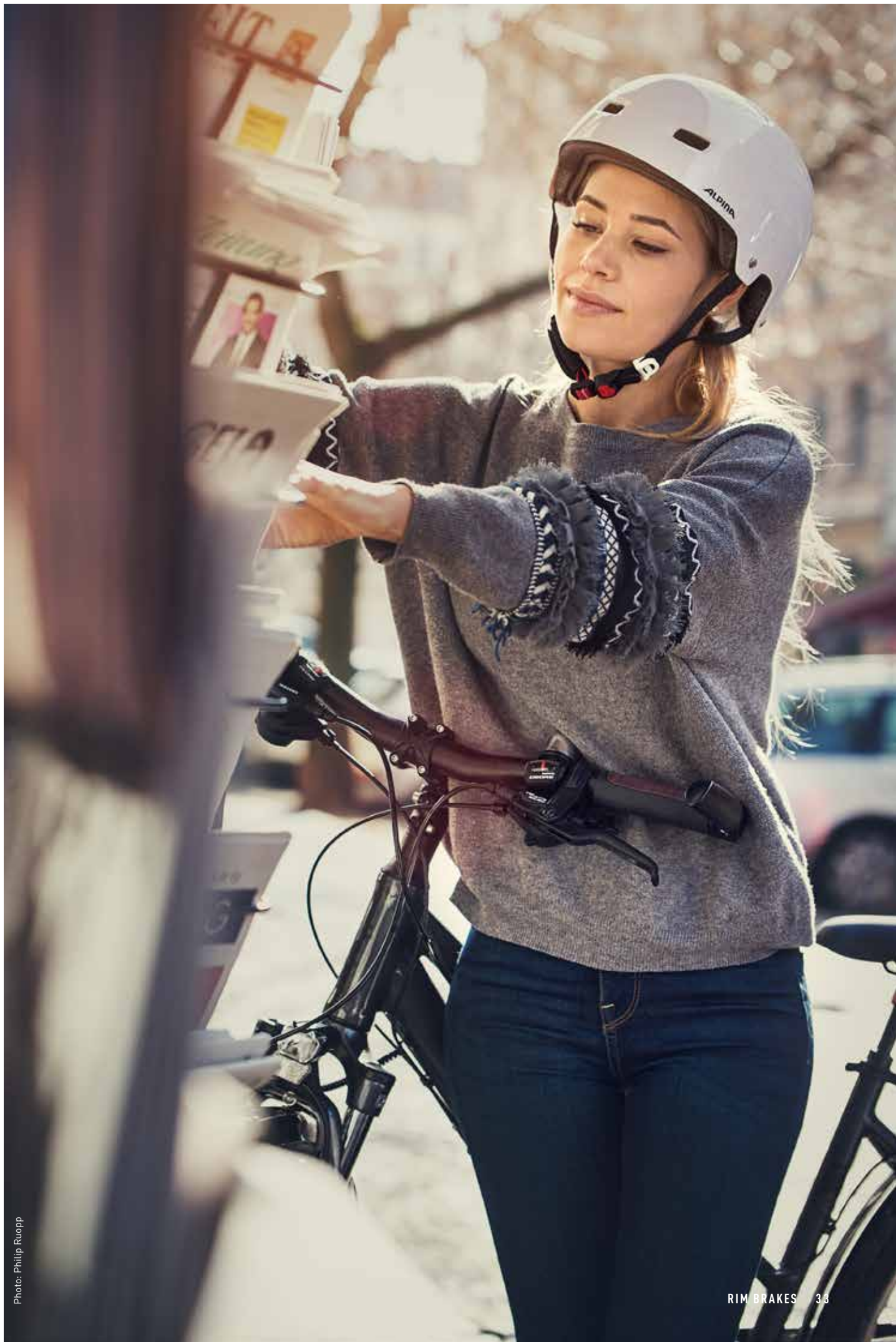





# S-PEDELEC BRAKES

# S-PEDELEC BRAKES TECHNOLOGY

.....

## 1 BRAKE POWER

4 Kolben für maximale Bremspower  
und Standfestigkeit  
4 pistons for maximum braking power  
and stability

.....

## 2 S-PEDELEC SWITCH

Aktiviert Bremslicht und/oder Antriebs-  
abschaltung beim Bremsen  
Activates brake light and/or controls the  
motor cut-off

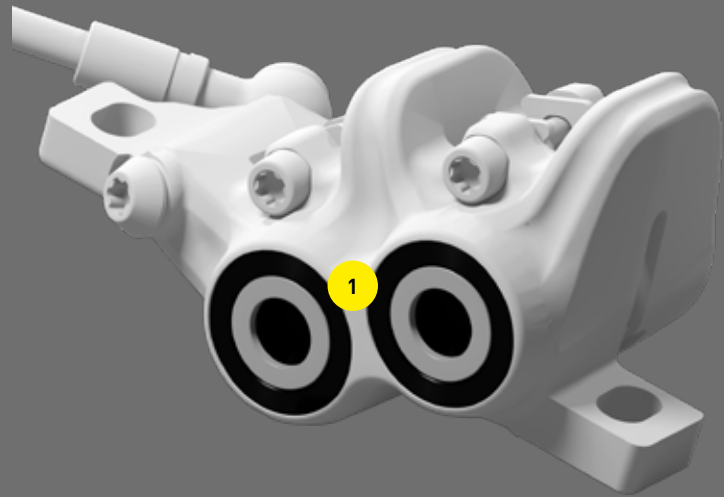

.....

## 3 BALL-END LEVER BLADE

Mehr Sicherheit am S-Pedelec durch den  
Kugelkopfhebel  
More safety for s-Pedelecs with the ball-  
end lever blade

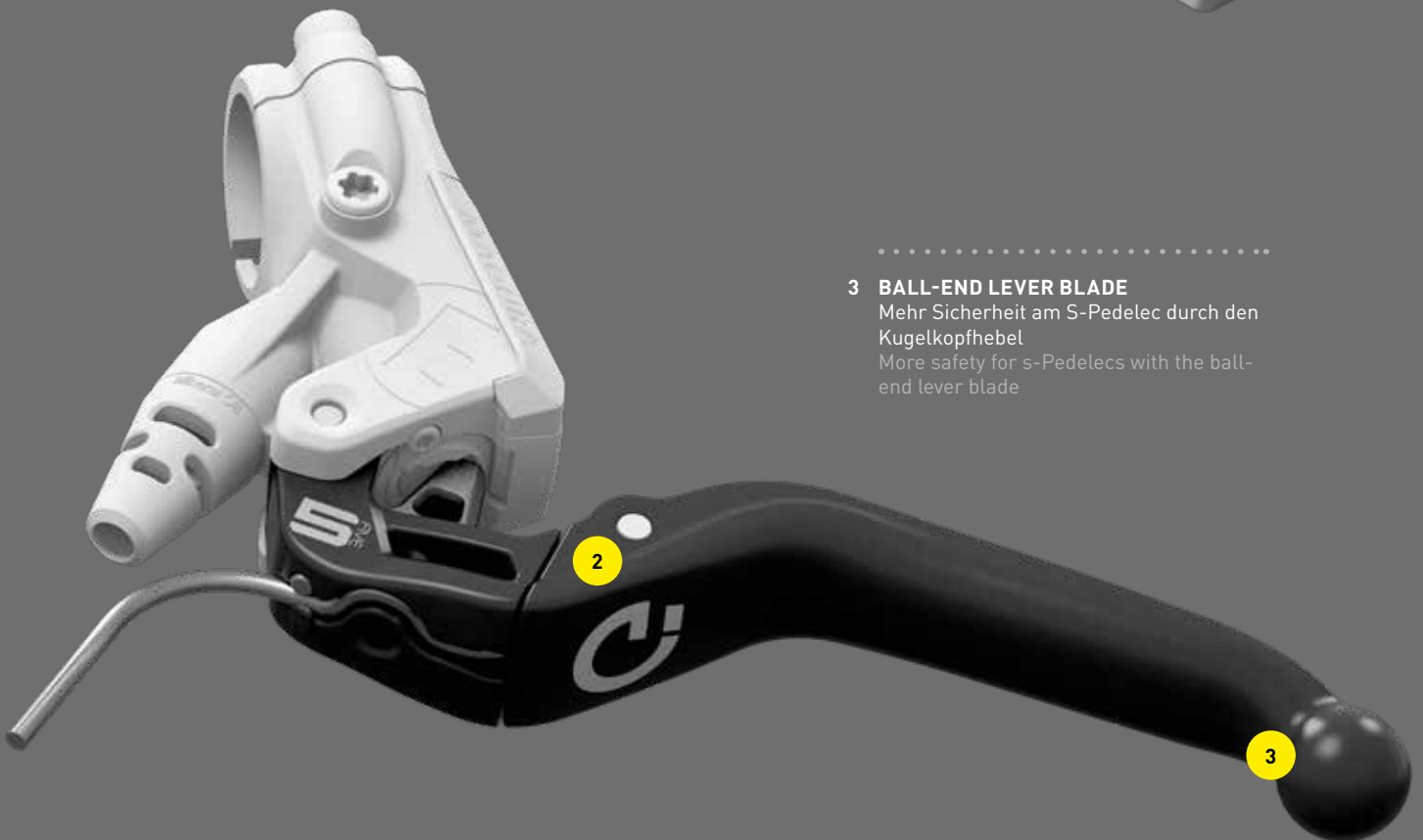

 DESIGNED AND  
ENGINEERED IN GERMANY

**5** YEARS LEAK  
PROOF GUARANTEE

 FILLED WITH  
ROYAL BLOOD

# MT5e

Bremst alles und stoppt den Motor – Erfahrungen aus dem Motorrad-Bereich gepaart mit Know-how für S-Pedelecs. Die Bremskraft der 4 Kolben und hohe Standfestigkeit verleihen S-Pedelecs mehr Sicherheit. Brakes everything including the motor – experience gained from the motorcycle sector coupled with know-how for s-pedelecs. The braking force of the 4 pistons and outstanding stability make s-pedelecs much safer.

Gewicht Weight	275 g
Bremsgriff Master	Carbotecture®
Bremshebel Lever blade	3-Finger ball-end, Aluminium mit Schalter 3-finger ball-end, aluminium with switch
Hebelweitenverstellung Reach adjust	Inbus SW3 3 mm allen key
Druckpunkteinstellung Bite adjust	-
Kolben Pistons	4
UVP RRP	139,90 €* 139,90 €*
Artikel-Nr. Order No.	2 700 984 <sup>d</sup>



Photo: Philip Ruopp

Alle Preise inkl. MwSt. All prices including VAT.  
 \* ohne Brems Scheibe/Adapter without rotor/adapter  
<sup>d</sup> 2 700 984: HIGO-Schließer HIGO-Closer / 2 700 985: HIGO-Öffner HIGO-Opener

# S-PEDELEC BRAKES

## MT4e

Sicherheit schreiben wir mit 4e: Schon vor der Verzögerung aktiviert ein Schalter der MT4e das Bremslicht und/oder schaltet den Antrieb ab. Unsere Allround-Scheibenbremse mit allen Features für S-Pedelecs.

Here, safety is spelled 4e: even before braking starts, a switch in the MT4e activates the brake light and/or cuts off the motor. Our all-round disc brake with all the features for s-pedelecs.

Gewicht Weight	250 g
Bremsgriff Master	Carbotecture®
Bremshebel Lever blade	3-Finger ball-end, Aluminium mit Schalter 3-finger ball-end, aluminium with switch
Hebelweitenverstellung Reach adjust	Inbus SW3 3 mm allen key
Druckpunkteinstellung Bite adjust	-
Kolben Pistons	2

Nur an Komplettbikes erhältlich.  
Not available in the aftermarket.



**S-PEDELEC TECHNOLOGY**  
**PERFECT ALL-ROUNDER**  
**LEVER BLADE FOR SAFETY**

## HS33e

Die HS33e ist eine hydraulische Felgenbremse, speziell für S-Pedelec-Modelle. Mit hoher Bremskraft und perfekter Ergonomie ist sie der ideale Partner für Stadt und Gelände.

The HS33e is a hydraulic rim brake specially designed for s-pedelec. With high braking power and perfect ergonomics, it's the ideal partner for town and country.

Gewicht Weight	500 g
Bremsgriff Master	Carbotecture®
Bremshebel Lever blade	3-Finger ball-end, Aluminium mit Schalter 3-finger ball-end, aluminium with switch
Hebelweitenverstellung Reach adjust	Torx T25 T25 tool
Belagverschleiß-nachstellung Pad wear adjustment	TPA
Anbau Mounting	Cantilever EV02

Nur an Komplettbikes erhältlich.  
Not available in the aftermarket.



**S-PEDELEC TECHNOLOGY**  
**THE LATEST MODEL OF THE CAREFREE BRAKE RANGE**  
**ELEGANT DESIGN AND HIGH-QUALITY MATERIALS**









MAGURA

# TUNING PARTS

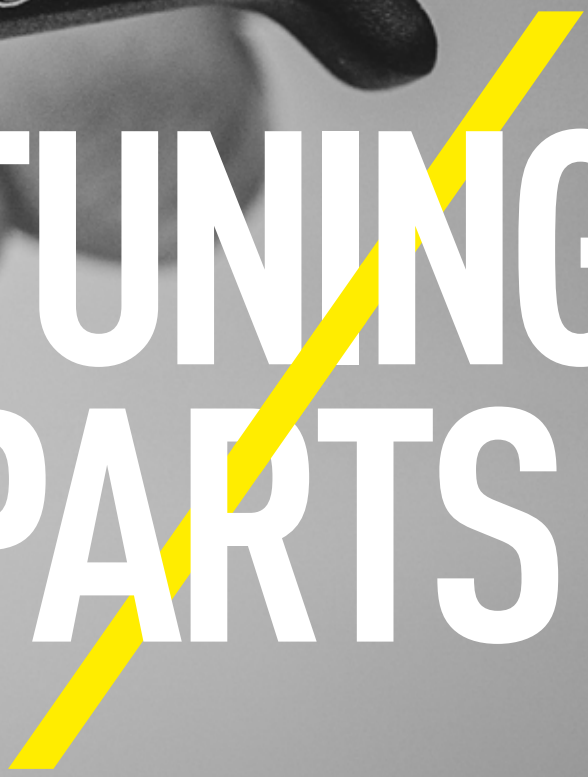

# TUNING PARTS

## LEVER BLADES

Wähle deinen Kontaktpunkt zur Bremse und finde die optimale Ergonomie.  
Choose your brake's contact point and lever blade ergonomics.

Für Carbotecture SL® (MT6/MT8/MT7/MT TRAIL CARBON/SL ab MJ 2015)  
For Carbotecture SL® (MT6/MT8/MT7/MT TRAIL CARBON/SL from MJ 2015)



<b>HC WIDE REACH BREMSHEBEL</b> <b>HC WIDE REACH LEVER BLADE</b>	<b>Artikelnummer</b> <b>Order Number</b>	<b>UVP</b> <b>RRP</b>
1-Finger Aluminium-Hebel, Reach Adjust mit Werkzeug (VE = 1 Stück) 1-finger aluminium lever blade, Reach Adjust with tool (PU = 1 piece)	2 702 070	39,90 €



<b>HC3 BREMSHEBEL</b> <b>HC3 LEVER BLADE</b>	<b>Artikelnummer</b> <b>Order Number</b>	<b>UVP</b> <b>RRP</b>
1-Finger Aluminium-Hebel, Reach Adjust mit Werkzeug, Ratio Adjust mit Werkzeug (VE = 1 Stück) 1-finger aluminium, Ratio Adjust with tool (PU = 1 piece)	2 701 251	67,90 €



<b>HC CARBON BREMSHEBEL</b> <b>HC CARBON LEVER BLADE</b>	<b>Artikelnummer</b> <b>Order Number</b>	<b>UVP</b> <b>RRP</b>
1-Finger Carbon-Hebel, Reach Adjust mit Werkzeug (VE = 1 Stück) 1-finger Carbon, Reach Adjust with tool (PU = 1 piece)	2 701 631	89,90 €



<b>HC BREMSHEBEL</b> <b>HC LEVER BLADE</b>	<b>Artikelnummer</b> <b>Order Number</b>	<b>UVP</b> <b>RRP</b>
1-Finger Aluminium-Hebel, Reach Adjust mit Werkzeug (VE = 1 Stück) 1-finger aluminium, Reach Adjust with tool (PU = 1 piece)	2 701 247	35,90 €



1-Finger Aluminium-Hebel, mit werkzeuglosen Reach Adjust, schwarz (VE = 1 Stück) 1-finger aluminium, with toolless Reach Adjust (PU = 1 piece)	2 701 246	37,90 €
--	-----------	---------



1-Finger Aluminium-Hebel, mit werkzeuglosen Reach Adjust, chrom (VE = 1 Stück) 1-finger aluminium, with toolless Reach Adjust, chrome (PU = 1 piece)	2 701 248	37,90 €
--	-----------	---------

<b>2-FINGER BREMSHEBEL</b> <b>2-FINGER LEVER BLADE</b>	<b>Artikelnummer</b> <b>Order Number</b>	<b>UVP</b> <b>RRP</b>
2-Finger Aluminium-Hebel mit werkzeuglosen Reach Adjust (VE = 1 Stück) 2-finger aluminium, with toolless Reach Adjust (PU = 1 piece)	2 701 215	37,90 €

# #CUSTOMIZE YOURBRAKE

Für Carbotecture (MT SPORT/MT4/MT5/MT eSTOP/MT TRAIL SPORT ab MJ 2015)  
 For Carbotecture (MT SPORT/MT4/MT5/MT eSTOP/MT TRAIL SPORT from MJ 2015)



**HC WIDE REACH BREMSHEBEL**  
**HC WIDE REACH LEVER BLADE**

**Artikelnummer**  
**Order Number**

**UVP**  
**RRP**

1-Finger Aluminium-Hebel, Reach Adjust mit Werkzeug (VE = 1 Stück) 1-finger aluminium lever blade, Reach Adjust with tool (PU = 1 piece)

2 702 071

39,90 €



**HC BREMSHEBEL**  
**HC LEVER BLADE**

**Artikelnummer**  
**Order Number**

**UVP**  
**RRP**

1-Finger Aluminium-Hebel, Reach Adjust mit Werkzeug, für MT TRAIL SPORT, ab MJ2017 (VE = 1 Stück) 1-finger aluminium, Reach Adjust with tool, for MT TRAIL SPORT, from MY2017 (PU = 1 piece)

2 701 369

34,90 €

1-Finger Aluminium-Hebel, Reach Adjust mit Werkzeug, für MT5 ab MJ2015 (VE = 1 Stück) 1-finger aluminium, Reach Adjust with tool, for MT5 from MY2015 (PU = 1 piece)

2 701 249

34,90 €

1-Finger Aluminium-Hebel, Reach Adjust mit Werkzeug, für MT4 (VE = 1 Stück) 1-finger aluminium, Reach Adjust with tool, for MT4 (PU = 1 piece)

2 701 250

34,90 €



**2-FINGER BREMSHEBEL**  
**2-FINGER LEVER BLADE**

**Artikelnummer**  
**Order Number**

**UVP**  
**RRP**

2-Finger Aluminium-Leichtbau-Hebel, Reach Adjust mit Werkzeug für MT5 oder MT TRAIL SPORT, ab MJ2015 (VE = 1 Stück) 2-finger aluminium light-weight lever blade, Reach Adjust with tool, for MT5 or MT TRAIL SPORT, from MY2015 (PU = 1 piece)

2 700 538

25,90 €



# TUNING PARTS

## RING KIT



### BLENDEN-RING KIT, 2 KOLBEN RING-KIT, 2 PISTONS

Blenden-Ring Kit für Bremszange, ab MJ 2015 (blau, neonrot, neongelb), (VE = 6 Stück)  
Ring-Kit for caliper, from MJ 2015 (blue, neon red, neon yellow), (PU = 6 pieces)

Artikelnummer  
Order Number

UVP  
RRP

2 701 239

9,90 €

Blenden-Ring Kit für Bremszange, ab MJ 2015 (lila, rot, pink), (VE = 6 Stück)  
Ring-Kit for caliper, from MJ 2015 (purple, red, pink), (PU = 6 pieces)

2 701 722

9,90 €

Blenden-Ring Kit für Bremszange, ab MJ 2015 (weiß, gold, silber), (VE = 6 Stück)  
Ring-Kit for caliper, from MJ 2015 (white, gold, silver), (PU = 6 pieces)

2 701 723

9,90 €

Blenden-Ring Kit für Bremszange, ab MJ 2015 (grün, cyan, mintgrün), (VE = 6 Stück)  
Ring-Kit for caliper, from MJ 2015 (green, cyan, mint green), (PU = 6 pieces)

2 701 724

9,90 €

### BLENDEN-RING KIT, 4 KOLBEN RING-KIT, 4 PISTONS

Blenden-Ring Kit für Bremszange, ab MJ 2015 (blau, neonrot, neongelb), (VE = 12 Stück)  
Ring-Kit for caliper, from MJ 2015 (blue, neon red, neon yellow), (PU = 12 pieces)

Artikelnummer  
Order Number

2 701 240

UVP  
RRP

13,90 €

Blenden-Ring Kit für Bremszange, ab MJ 2015 (lila, rot, pink), (VE = 12 Stück)  
Ring-Kit for caliper, from MJ 2015 (purple, red, pink), (PU = 12 pieces)

2701719

13,90 €

Blenden-Ring Kit für Bremszange, ab MJ 2015 (weiß, gold, silber), (VE = 12 Stück)  
Ring-Kit for caliper, from MJ 2015 (white, gold, silver), (PU = 12 pieces)

2701720

13,90 €

Blenden-Ring Kit für Bremszange, ab MJ 2015 (grün, cyan, mintgrün), (VE = 12 Stück)  
Ring-Kit for caliper, from MJ 2015 (green, cyan, mint green), (PU = 12 pieces)

2701721

13,90 €

## INDIVIDUAL COVER

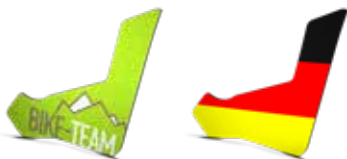

### INDIVIDUELLE COVER INDIVIDUAL COVERS

Für Carbotecture SL (MT6/MT8/MT7/MT TRAIL CARBON/SL ab MJ 2015)  
For Carbotecture SL (MT6/MT8/MT7/MT TRAIL CARBON/SL from MJ 2015)

UVP  
RRP

14,90 € / 19,90 €

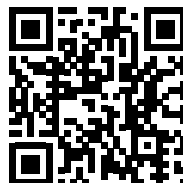

Erstelle hier dein individuelles Cover!  
Design your individual cover here!

[WWW.MAGURA.COM/CUSTOMIZE](http://WWW.MAGURA.COM/CUSTOMIZE)

# HANDLEBAR CLAMPS



## SHIFTMIX KLEMMSCHELLE SHIFTMIX HANDLEBAR CLAMP

	Artikelnummer Order Number	UVP RRP
Shiftmix 1+2, für Shimano I-Spec I+II Schalt- hebel, schwarz Shiftmix 1+2 set, for Shimano I-Spec I+II, black	Set set (l/r): 2 701 952 Links left: 2 701 953 Rechts right: 2 701 954	39,90 € 20,90 € 20,90 €
Shiftmix 1+2, für Shimano I-Spec I+II Schalt- hebel, silber Shiftmix 1+2 set, for Shimano I-Spec I+II, silver	Set set (l/r): 2 702 063 Links left: 2 702 064 Rechts right: 2 702 065	39,90 € 20,90 € 20,90 €
Shiftmix 3 für SRAM Matchmaker® Schalt- hebel, schwarz Shiftmix 3 set, for SRAM Matchmaker® shifters, black	Set set (l/r): 2 701 949 Links left: 2 701 950 Rechts right: 2 701 951	39,90 € 20,90 € 20,90 €
Shiftmix 3 für SRAM Matchmaker® Schalt- hebel, silber Shiftmix 3 set, for SRAM Match- maker® shifters, silver	Set set (l/r): 2 702 066 Links left: 2 702 067 Rechts right: 2 702 068	39,90 € 20,90 € 20,90 €
Shiftmix 4 Set, für Shimano I-Spec EV Schalt- hebel, schwarz Shiftmix 4 set, for Shimano I-Spec EV, black	Set set (l/r): 2 702 189 Links left: 2 702 190 Rechts right: 22 702 191	39,90 € 20,90 € 20,90 €



## KLEMMSCHELLE HANDLEBAR CLAMP

	Artikelnummer Order Number	UVP RRP
Carbon, ohne Schrauben (VE = 1 Stück) Carbon, no screws (PU = 1 piece)	0 724 709	20,90 €
Aluminium, neon-gelb, ohne Schrauben (VE = 1 Stück) Aluminium, neon yellow, no screws (PU = 1 piece)	2 700 751	11,90 €
Aluminium, neon-rot, ohne Schrauben (VE = 1 Stück) Aluminium, neon red, no screws (PU = 1 piece)	2 700 752	11,90 €
Aluminium, cyan-blau, ohne Schrauben (VE = 1 Stück) Aluminium, neon blue, no screws (PU = 1 piece)	2 700 753	11,90 €
Aluminium, chrom poliert, ohne Schrauben (VE = 1 Stück) Aluminium, chrome polished, no screws (PU = 1 piece)	2 701 244	9,90 €
Aluminium, schwarz, ohne Schrauben (VE = 1 Stück) Aluminium, black, no screws (PU = 1 piece)	2 702 054	9,90 €
Aluminium, silber, ohne Schrauben (VE = 1 Stück) Aluminium, silver, no screws (PU = 1 piece)	2 702 069	9,90 €
Carbotecture®, schwarz, ohne Schrauben (VE = 1 Stück) Carbotecture®, black, no screws (PU = 1 piece)	2 700 136	7,90 €
Carbotecture®, silber, ohne Schrauben (VE = 1 Stück) Carbotecture®, silver, no screws (PU = 1 piece)	2 700 137	7,90 €





# ORIGINAL SPARE PARTS

ORIGINAL SPARE PARTS  
BEST PARTS = BEST PERFORMANCE

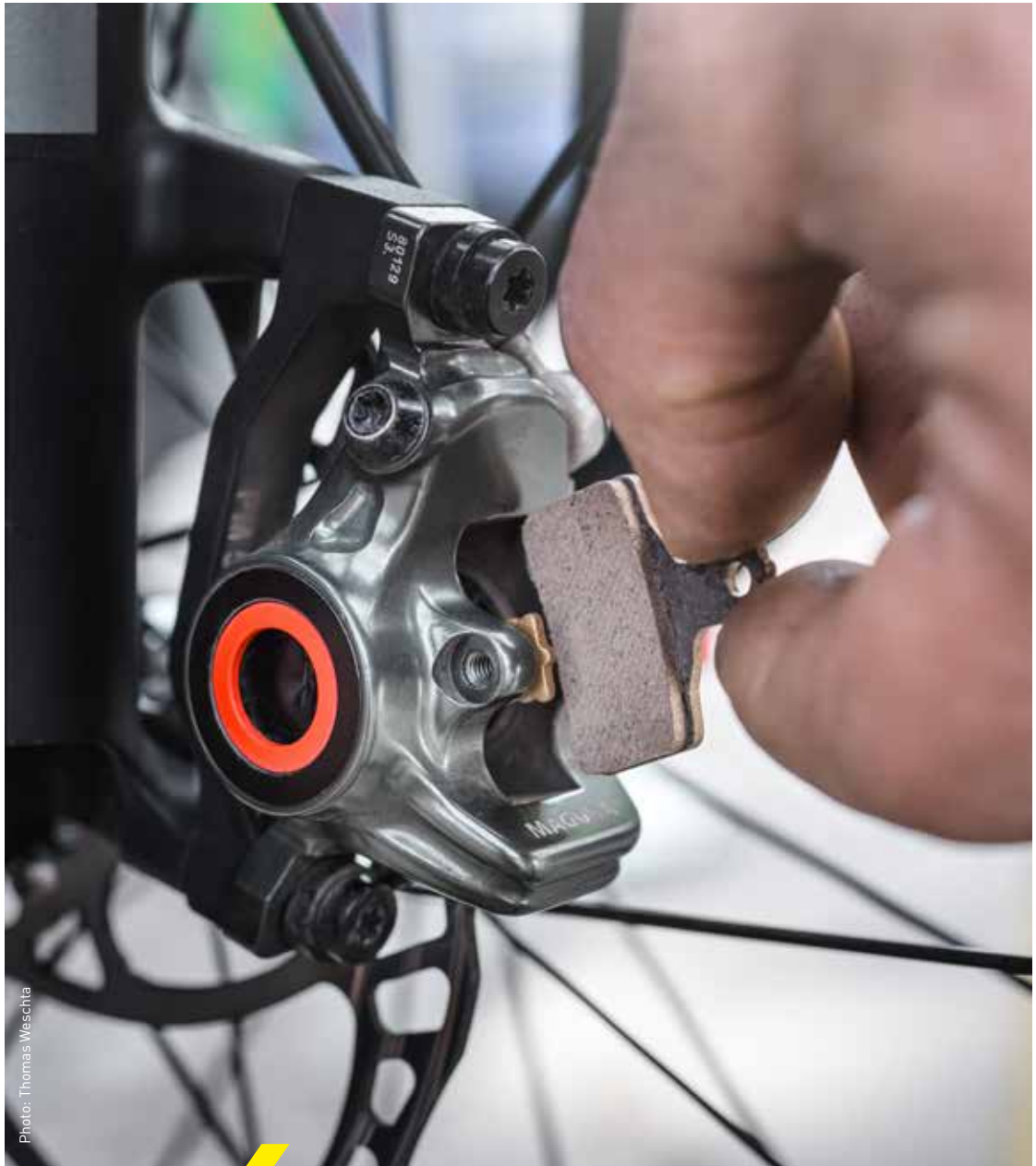

Photo: Thomas Weschta

**SAFETY  
MATTERS**



# BRAKE PADS OVERVIEW

## DISC BRAKE PADS

### R-RACE

Für alle, die ihr Material beim Cross Country oder Downhill an die Grenzen bringen und höchste Verzögerung benötigen. For those who take their equipment to the limits and require outstanding cross country or downhill braking power.



### P-PERFORMANCE inkl. ECE incl. ECE

Für lange Touren immer genug Sicherheit bei sehr guter Performance in allen Eigenschaften. Intended for long rides, these pads offer safety together with excellent performance in all conditions.



### S-SPORT inkl. ECE incl. ECE

Durch höhere Bremskraft, längere Haltbarkeit und verkürzte Einbremsdauer für den Einsatz am E-Bike optimiert. Due to its powerful braking capabilities together with high durability and shorter bed-in time, this is a perfect brake pad for use with e-bikes.

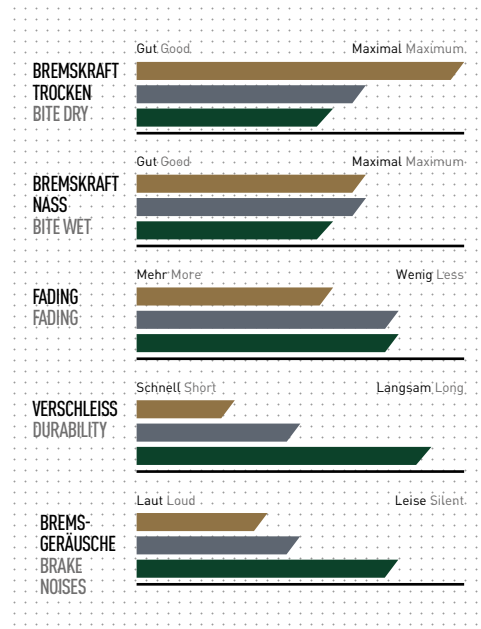

### Wichtig: Bremsbeläge einfahren! Important: Bed-in brake pads!

Neue Bremsbeläge entwickeln ihre endgültige Bremskraft erst während der Einfahrphase. Hierfür auf ebener Strecke auf 30 km/h beschleunigen. Mit einer Bremse bis zum Stillstand abbremsen. Diesen Vorgang pro Bremse mindestens 30 Mal wiederholen. Bremsbeläge und -scheiben sind nun eingefahren und bieten optimale Bremsleistung.

The bed-in phase is essential to ensure you get maximum braking power out of your new brake pads. To do this, accelerate to a speed of 30 km/h on a level road. Use one brake to decelerate to a standstill. Repeat this procedure at least 30 times per brake. Brake pads and rotors have now been bedded-in and will provide optimum braking performance.

## RIM BRAKE PADS

Felgentyp prüfen!  
Check your rim type!

### BLACK RED

Für unbeschichtete Aluminiumfelgen.  
For uncoated aluminium rims.

### GREY GREEN

Für harteloxierte Aluminium- und Keramikfelgen.  
For hard coated aluminium and ceramic rims.



### BLACK GREY

**Hohe Langlebigkeit** – Ob eine Tagestour oder eine Reise um die Welt. Über den Service deiner Bremse musst du dir erst danach Gedanken machen. High durability – Whether a day trip or a trip around the world. You'll only have to think about servicing your brake afterwards.

### RED GREEN

**Hohe Bremspower** – Dein Bike ist täglich bei jedem Wetter im Einsatz. Viele Ampeln und Stopps erfordern die maximale Leistung deiner Bremse. High braking power – Your bike is daily in use in all weather conditions. Many traffic lights and stops require the maximum power of your brakes.

# ORIGINAL SPARE PARTS

## BRAKE PADS



<b>BREMSBELAG 9.P</b> <b>BRAKE PAD 9.P</b>	<b>Artikelnummer</b> <b>Order Number</b>	<b>UVP</b> <b>RRP</b>
9.P Performance – Bremsbelag für 4-Kolben Bremszange ab MJ 2015, inkl. ECE-Kennzeichnung 9.P Performance – Brake pad for 4-pistons caliper from MY2015, incl. ECE marking	2 701 627	19,90 €



<b>BREMSBELAG 8.R / 8.P / 8.S</b> <b>BRAKE PAD 8.R / 8.P / 8.S</b>	<b>Artikelnummer</b> <b>Order Number</b>	<b>UVP</b> <b>RRP</b>
8.R Race – Bremsbelag für 4-Kolben Bremszange ab MJ 2015 8.R Race – Brake pad for 4-pistons caliper from MY2015	2 701 173	29,90 €
8.P Performance – Bremsbelag für 4-Kolben Bremszange ab MJ 2015, inkl. ECE-Kennzeichnung 8.P Performance – Brake pad for 4-pistons caliper from MY2015, incl. ECE marking	2 701 628	22,90 €
8.S Sport – Bremsbelag für 4-Kolben Bremszange ab MJ 2015, inkl. ECE-Kennzeichnung 8.S Sport – Brake pad for 4-pistons caliper from MY2015, incl. ECE marking	2 701 925	19,90 €



<b>BREMSBELAG 7.R / 7.C / 7.S</b> <b>BRAKE PAD 7.R / 7.C / 7.S</b>	<b>Artikelnummer</b> <b>Order Number</b>	<b>UVP</b> <b>RRP</b>
7.R Race – Bremsbelag für 2-Kolben Bremszange ab MJ 2012 7.R Race – Brake pad for 2-pistons caliper from MY2012	2 701 179	24,90 €
7.P Performance – Bremsbelag für 2-Kolben Bremszange ab MJ 2012, inkl. ECE-Kennzeichnung 7.P Performance – Brake pad for 2-pistons caliper from MY2012, incl. ECE marking	2 701 625	19,90 €
7.S Sport – Bremsbelag für 2-Kolben Bremszange ab MJ 2012, inkl. ECE-Kennzeichnung 7.S Sport – Brake pad for 2-pistons caliper from MY2012, incl. ECE marking	2 701 927	17,90 €



<b>FELGEN BREMSBELÄGE</b> <b>RIM BRAKE PADS</b>	<b>Artikelnummer</b> <b>Order Number</b>	<b>UVP</b> <b>RRP</b>
Bremsbelag schwarz für HS11/HS22/HS33 Brake pad black for HS11/HS22/HS33	2 701 576	19,90 €
Bremsbelag grau für HS11/HS22/HS33 Brake pad grey for HS11/HS22/HS33	0 321 407	19,90 €
Bremsbelag rot für HS11/HS22/HS33 Brake pad red for HS11/HS22/HS33	0 720 423	23,90 €
Bremsbelag grün für HS11/HS22/HS33 Brake pad green for HS11/HS22/HS33	0 720 439	23,90 €

# ORIGINAL SPARE PARTS

## ROTORS



### MDR-P

Bietet dank spezieller, patentierter Verzahnung des Außen- und Innenrings (Dovetail Interlink Technologie) auch bei hoher Dauerbelastung konstante Bremsperformance. Zudem höchste Hitzebeständigkeit und Standfestigkeit. Offering a special patented interlocking of the outer and inner rings (Dovetail Interlink Technology) giving optimum braking performance even under heavy loads. In addition, maximum heat resistance and stability.



**WARNING:** Bremsscheibe nicht mit Centerlock Adapter verwenden!  
**WARNING:** Never use rotor with centerlock adapter!

Durchmesser Diameter	Gewicht Weight	Artikelnummer Order Number	UVP RRP
180 mm	190 g	2 701 937	55,00 €
203 mm	216 g	2 701 938	55,00 €
220 mm	241 g	2 701 939	55,00 €



**NEW**

### MDR-P CL

Bietet dank spezieller, patentierter Verzahnung des Außen- und Innenrings (Dovetail Interlink Technologie) auch bei hoher Dauerbelastung konstante Bremsperformance. Zudem höchste Hitzebeständigkeit und Standfestigkeit. Centerlock Befestigung, inkl. Lockring.  
 "Offering a special patented interlocking of the outer and inner rings (Dovetail Interlink Technology) giving optimum braking performance even under heavy loads. In addition, maximum heat resistance and stability. Centerlock mounting incl. lockring"



Für Schnellspannachse inkl. Lockring  
 For quick-release axle incl. lockring

Durchmesser Diameter	Gewicht Weight	Artikelnummer Order Number	UVP RRP
180	211 g	2702228	60,00 €
203	226 g	2702230	60,00 €

# ORIGINAL SPARE PARTS

## ROTORS



### MDR-C

Dank des zusätzlichen Verbindungsring ist die einteilige E-Bike optimierte Bremscheibe besonders steif, schwingungsresistent und der ideale Allrounder – ob am Stadt-, Trail- oder E-Bike.

Thanks to the additional connecting ring the one-piece rotor, optimized for e-bikes is particularly stiff, vibration resistant and the ideal all-rounder - whether on city, trail or e-bike.



Durchmesser Diameter	Gewicht Weight	Artikelnummer Order Number	UVP RRP
160 mm	140 g	2 701 917	30,00 €
180 mm	162 g	2 701 918	30,00 €
203 mm	222 g	2 701 919	30,00 €



### MDR-C CL

Zweiteilige Bremscheibe für beste Bremskraft bei hohen Belastungen. Ausgestattet mit einer Centerlock-Aufnahme für entsprechende Naben.

A two-piece rotor for the best brake power at high loads. Equipped with a centerlock fitting for corresponding hubs.



Für Schnellspannaxse inkl. Lockring

For quick-release axle incl. lockring

Durchmesser Diameter	Gewicht Weight	Artikelnummer Order Number	UVP RRP
160 mm	175 g	2 702 234	35,00 €
180 mm	195 g	2 702 236	35,00 €
203 mm	225 g	2 702 238	35,00 €

Für Steckachse inkl. Lockring

For thru axle incl. lockring

Durchmesser Diameter	Gewicht Weight	Artikelnummer Order Number	UVP RRP
160 mm	175 g	2 702 235	35,00 €
180 mm	195 g	2 702 237	35,00 €
203 mm	225 g	2 702 239	35,00 €



### STORM SL.2

Sehr gute Bremskraft bei minimalem Eigengewicht. Optimiert für den Cross Country-Einsatz.

Fantastic brake power with minimum weight. Optimized for the cross Country use.

Durchmesser Diameter	Gewicht Weight	Artikelnummer Order Number	UVP RRP
160 mm	100 g	2 701 348	35,00 €
180 mm	118 g	2 701 349	35,00 €



### STORM HC (ABE OPTIONAL)

Optimiert für beste Bremskraft bei hohen Belastungen und leichtem Gewicht. Empfohlen für den Trail- und Gravity-Einsatz. Dank ABE auch am S-Pedelec bedenkenlos nachrüstbar.

Optimized for best braking power at high loads as well as its light weight. Recommended for trail and Gravity use. Owing to ABE also on the S-pedelec can be retrofitted without hesitation.



Ohne ABE  
Without ABE

Durchmesser Diameter	Gewicht Weight	Artikelnummer Order Number	UVP RRP
160 mm	121 g	2 702 451	30,00 €
180 mm	140 g	2 702 452	30,00 €
203 mm	173 g	2 702 453	30,00 €

Mit ABE  
With ABE

Durchmesser Diameter	Gewicht Weight	Artikelnummer Order Number	UVP RRP
160 mm	121 g	2 700 928	35,00 €
180 mm	140 g	2 700 929	35,00 €
203 mm	173 g	2 700 930	35,00 €

# ORIGINAL SPARE PARTS

## ADAPTER



### ADAPTER PM / IS ADAPTERS PM / IS

QM 40	Artikelnummer Order Number	UVP RRP
PM 140-160 / PM 160-180 / PM 200-220 (VE = 1 Stück) PM 140-160 / PM 160-180 / PM 200-220 (PU = 1 piece)	2 700 515	10,00 €



QM 41	Artikelnummer Order Number	UVP RRP
IS-180-R (VE = 1 Stück) IS-180-R (PU = 1 piece)	2 700 516	10,00 €



QM 42	Artikelnummer Order Number	UVP RRP
PM 160-203 (VE = 1 Stück) PM 160-203 (PU = 1 piece)	2 700 517	10,00 €



QM 43	Artikelnummer Order Number	UVP RRP
IS-160-F (VE = 1 Stück) IS-160-F (PU = 1 piece)	2 700 518	10,00 €



QM 5	Artikelnummer Order Number	UVP RRP
IS-203-F (VE = 1 Stück) IS-203-F (PU = 1 piece)	0 722 321	10,00 €



QM 9	Artikelnummer Order Number	UVP RRP
IS-203-R (VE = 1 Stück) IS-203-R (PU = 1 piece)	0 722 325	10,00 €



QM 12	Artikelnummer Order Number	UVP RRP
IS-160-R / IS-180-F (VE = 1 Stück) IS-160-R / IS-180-F (PU = 1 piece)	0 722 426	10,00 €



**QM 44**

PM 180-203 (VE = 1 Stück)  
PM 180-203 (PU = 1 piece)

Artikelnummer Order Number	UVP RRP
2 701 967	10,00 €



**QM 45**

PM 180-220 / PM 140-180 (VE = 1 Stück)  
PM 180-220 / PM 140-180 (PU = 1 piece)

Artikelnummer Order Number	UVP RRP
2 701 940	10,00 €



**QM 46**

PM 203-220 (VE = 1 Stück)  
PM 203-220 (PU = 1 piece)

Artikelnummer Order Number	UVP RRP
2 702 193	10,00 €

**ADAPTER FLATMOUNT  
ADAPTER FLATMOUNT**



**QM 50**

FM140/160 - 160F / FM160/180 - 180F (VE = 1 Set)  
FM140/160 - 160F / FM160/180 - 180F (PU = 1 set)

Artikelnummer Order Number	UVP RRP
2 701 598	15,00 €



**QM 51**

FM140/160 - 160R / FM160/180 - 180R (VE = 1 Set)  
FM140/160 - 160R / FM160/180 - 180R (PU = 1 set)

Artikelnummer Order Number	UVP RRP
2 701 600	15,00 €



**QM 52**

FM160/180 - 160F (VE = 1 Set)  
FM160/180 - 160F (PU = 1 set)

Artikelnummer Order Number	UVP RRP
2 702 193	15,00 €

**PM 180-220 F**

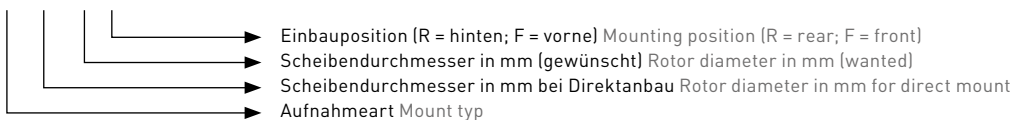

# ORIGINAL SPARE PARTS SERVICE PRODUCTS



## ROYAL BLOOD

MAGURA Royal Blood, 100 ml  
MAGURA Royal Blood, 250 ml  
MAGURA Royal Blood, 1000 ml

Artikelnummer  
Order Number

UVP  
RRP

2 702 137  
2 702 139  
2 702 138

7,60 €  
17,50 €  
33,50 €

# BECAUSE QUALITY MATTERS



Photo: Philip Ruopp





#### SERVICE KIT

Service Kit (für Scheiben- und Felgenbremsen), Inhalt: 100 ml Royal Blood, zwei Spritzen inkl. Schlauch, Torx T25 Schlüssel, Montagebacken, Kleinteile und Stützen zum Leitungskürzen  
 Service Kit (for disc and rim brakes), Contents: 100 ml Royal Blood, 2 × syringes incl. bleed tubing, Torx T25, 2 × installing clamps, small parts and inserts for hose shortening

Artikelnummer Order Number	UVP RRP
2 700 191	33,00 €



#### PROFI-ENTLÜFTUNGSKIT PROFESSIONAL BLEED KIT

Profi-EntlüftungsKit (für Scheiben- und Felgenbremsen), Inhalt: Spritze, Schlauch mit EBT-Befüllstopfen, Schlauch mit Gewindeaufsatz, 250 ml Kunststoffflasche inkl. Haken, 250 ml Royal Blood  
 Professional bleed kit (for disc and rim brakes), contents: Syringe, bleed tubing with EBT filling plug, bleed tubing with thread attachment, 250 ml plastic bottle including hook, 250 ml Royal Blood

Artikelnummer Order Number	UVP RRP
0 724 492	46,90 €



#### TORQUE TOOL

MAGURA Drehmomentschlüssel 2,0 - 8,0 Nm inkl. 6 bits (VE = 1 Set)  
 MAGURA torque tool 2,0 - 8,0 Nm inkl. 6 bits (PU = 1 set)

Artikelnummer Order Number	UVP RRP
2702428	99,90€





# APPAREL

MAGURA BY MALOJA  
— 3RD GENERATION

**maloja** 

# BIKEWEAR



## MAGURA Primaloft Windblock Jacket

Windblock Jacke mit wärmender Primaloft Wattierung auf Front und hinterer Schulter. Dank dem besonders kleinen Packmaß, lässt sich die Jacke sogar in der Trikottasche oder im Hip-Bag verstauen.

Windblock jacket with warming Primaloft padding on the front and back shoulders. Thanks to the particularly small packing size, the jacket can even be stowed in the jersey pocket or the hip bag.

**Style:** Men  
**Größen Sizes:** XS – XL  
**UVP RRP:** 150,00 €

## MAGURA Yellow Freeride Short

Ergonomisch vorgeformte Freeride Short mit längerem Schnitt – perfekt für das Tragen von Knieschonern. Dank Spandex Multistretch Material und Weitenregulierung am Bund macht sie jede Bewegung mit.

Ergonomically pre-shaped Freeride shorts with a longer shape – perfect for wearing knee pads. These shorts will faithfully follow your every move, thanks to the Spandex Multistretch fabric and the adjustable waistband.

**Style:** Unisex  
**Größen Sizes:** S – XXL  
**UVP RRP:** 130,00 €



.....

**MAGURA YellowCamo Freeride Jersey**  
**MAGURA YellowCamo Freeride Jersey Longsleeve**

Lockerer Freeride Jersey aus einem besonders schnell trocknendem Moondry-Material mit kühlenden Mesh-Elementen. Dank Polygiene dauerhaft geruchsfrei.

Loose-fitting freeride jersey made of a very fast drying "Moondry" material with cooling mesh elements. Permanently odourless, thanks to Polygiene.

**Style:** Unisex  
**Größen** Sizes: XS – XXL  
**UVP RRP:** 80,00 € / 108,00 €



.....

**MAGURA YellowCamo Endurance Jersey**

Luftiges und schnelltrocknendes Endurance Radtrikot in Gelb und dezentem Camouflage. Race-typisch enger Schnitt mit längeren Ärmeln und langem Rücken.

Airy and fast-drying endurance cycling jersey in yellow and discreet camouflage. Race-typical close cut with longer sleeves and long back.

**Style:** Unisex  
**Größen** Sizes: XS – XXL  
**UVP RRP:** 108,00 €



# STREETWEAR



## MAGURA Check Shirt

Klassisch kariertes Hemd im MAGURA Design mit kurzem Kragen und Brusttasche. Hergestellt aus 100 % Baumwolle.

Classic check shirt in MAGURA design with short collar and chest pocket. Made from 100 % cotton.

**Style:** Men  
**Größen** Sizes: S–XL  
**UVP** RRP: 84,00 €



## MAGURA Rotor Sweatshirt

Modernes Rundhals Sweatshirt mit Brusttasche und aufwendigem Bremscheiben Designprint. Angenehm zu tragen dank Raglan Schnitt und 100 % Biobaumwolle. Made in Portugal.

Fashionable round-neck sweatshirt with breast pocket and captivating rotor print design. Comfortable to wear thanks to its raglan design and 100 % organic cotton. Made in Portugal.

**Style:** Unisex  
**Größen** Sizes: XS–XXL  
**UVP** RRP: 84,00 €

/  
STYLED BY  
MALOJA & MAGURA  
/



.....

### MAGURA Multi-Use Pant

Technische Multisport- und Freizeitthose mit Weitenregulierung am Beinabschluss. Angenehmer Tragekomfort durch vorgeformte Knie und leichten Stretch.

Technical multisport and leisure pants with adjustable leg end. Preformed knees and lightly stretchable material make it extremely comfortable to wear.

**Style:** Men  
**Größen** Sizes: S - XL  
**UVP RRP:** 132,00 €





.....

### MAGURA Brake T-Shirt Men/Women

Basic T-Shirt mit auffällig buntem Frontprint „BRAKE“. Hergestellt aus 100% Bio-Baumwolle. Made in Portugal.

Basic T-shirt with a striking colourful “BRAKE” print design on the front. Made from 100% organic cotton. Made in Portugal.

**Style:** Men/Women  
**Größen** Sizes: S-XXL/XS-XL  
**UVP** RRP: 44,00€



.....

### MAGURA Rotor T-Shirt Men/Women

Locker geschnittenes T-Shirt mit Brusttasche und aufwendigem Bremsscheiben Designprint. Hergestellt aus 100% Bio-Baumwolle. Made in Portugal.

Loose-fitting T-shirt with breast pocket and elaborate rotor print design. Made from 100% organic cotton. Made in Portugal.

**Style:** Men/Women  
**Größen** Sizes: S-XXL/XS-XL  
**UVP** RRP: 50,00€







.....

### MAGURA Piquee Polo Men/ Women

Klassisches Piquee Polo mit MAGURA Logo auf der Brust. Hergestellt aus festem und robustem Stoff mit geripptem Kragen und Ärmelabschlüssen. 100% Bio Baumwolle.

Classic Pique Polo with MAGURA logo on the chest. Made of tough, durable fabric with ribbed collar and cuffs. 100% organic cotton.

**Style:** Men/Women  
**Größen** Sizes: S-XXL/S-XL  
**UVP** RRP: 72,00€



.....

### MAGURA Steel Bottle

Einwandige MIZU Stahl 800 ml Trinkflasche mit 100% BPA freiem Deckel.

Single-walled MIZU steel 800 ml drinking bottle with 100% BPA-free lid.

**Größen** Sizes: 800 ml  
**UVP** RRP: 30,00€

Alle Preise inkl. MwSt.  
 All prices incl. VAT.

# SPONSORED RIDERS AND TEAMS



**FABIO  
WIBMER**

AWESOME RIDERS  
AND FRIENDS!



**DANNY  
MACASKILL**

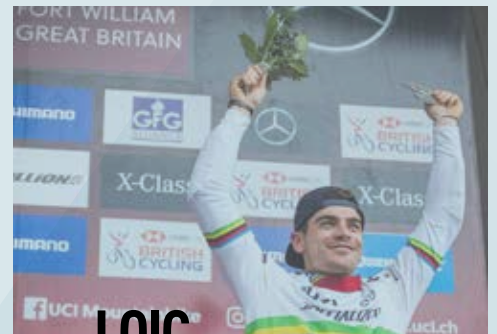

**LOIC  
BRUNI**



**NORCO  
TWINS  
RACING**



**BRETT  
TIPPIE**

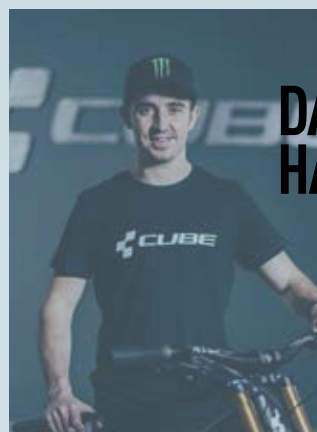

**DANNY  
HART**



**JOHANNES  
FISCHBACH**



**JASPER  
JAUCH**

**RAD  
BANDITS  
FACTORY  
TEAM**



**KOVARIK  
RACING**

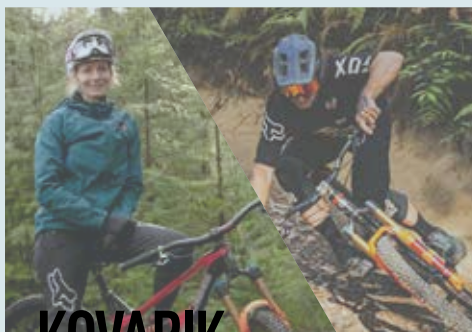

**CST POSTNL  
BAFANG  
MOUNTAINBIKE  
RACING TEAM**



**TEAM  
TREK  
PIRELLI**



**ELISABETH  
BRANDAU**



**TREK-VAUDE**

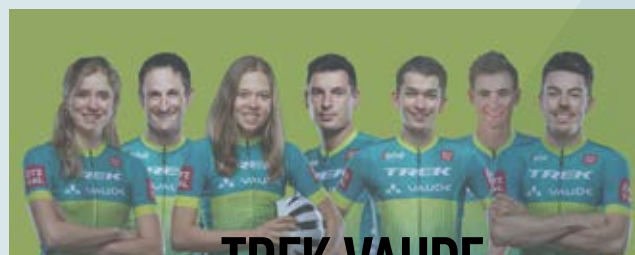

**STEFAN  
SCHLIE**



**DENIS  
KATZER**



**MORE RIDERS  
& TEAMS**

Full listing at [magura.com](http://magura.com)

Andreas Kromer, Benny Strasser, Bikepark La Bresse, Bikepark Lienz, Cube Factory Racing, Cube Team France, Drop'n Roll, Elliott Lapotre, German Technology Racing Team, Jonas Lindberg, Kurt Resch, Maja Micherda, Maloja Pushbikers MTB Team, Max Schumann, MTB Academy, Manfred Stromberg, Philipp Foltz, Specialized Gravity Team, Tom Barrer, Tina Lang, Tobias Woggon, Tibor Simai, Tom Oehler

# PRODUCT TABLE: BRAKES

		MT7 PRO	MT5	MT5 eSTOP	MT TRAIL SL	MT TRAIL SPORT	MT8 SL	MT8 PRO	MT4	MT4 eSTOP	MT SPORT	CT5	CT4	HS33	HS22	HS11	
<b>Gewicht (g)</b> Weight (g)	MT/IS	255 <sup>B</sup>	255 <sup>B</sup>	255 <sup>B</sup>	230 <sup>A</sup>	245 <sup>A</sup>	195 <sup>B</sup>	225 <sup>B</sup>	230 <sup>B</sup>	255 <sup>B</sup>	245 <sup>B</sup>	295 <sup>B</sup>	280 <sup>B</sup>	480 <sup>C</sup>	480 <sup>C</sup>	435 <sup>C</sup>	
	Flatmount						185 <sup>B</sup>		220 <sup>B</sup>				265 <sup>B</sup>				
<b>Material</b>	Bremszange Caliper	Aluminium	•	•	•	•	•	•	•	•	•	•	•	•	•	•	
	Bremsgriff Master	Carbotecture SL®	•			•		•	•								
		Carbotecture®		•	•		•			•	•	•	•	•	•	•	
	Bremshebel Lever blade	Carbon				•		•								•	•
Carbotecture®											•	•	•		•	•	
Aluminium			•	•					•	•				•			
	Hollow Aluminium	•				•		•									
<b>Bremshebel</b> Lever blade	1-Finger HC	•			•	•	•	•									
	2-Finger		•	•					•	•	•			•			
	3-Finger											•	•		•	•	
	3-Finger ball-end			•(e)					•(e)					•(e)			
<b>E-Bike Schalter</b> Switch			•(e)					•(e)						•(e)			
<b>Features</b>	EBT	•	•	•	•	•	•	•	•	•	•	•	•	•	•	•	
	TPA													•	•		
	Brake Booster													•	•		
	Banjofitting Zange Caliper	•	•	•	•	•	•	•	•	•							
	2 Kolben 2 pistons					• rear	• rear	•	•	•	•		•				
	4 Kolben 4 pistons	•	•	•	• front	• front						•					
	Reach Adjust	mit Werkzeug with tool		•	•	•	•	•		•	•	•			•		
		werkzeuglos toolless	•						•				•	•		•	
<b>Empfohlene Bremscheiben<sup>D</sup></b> Recommended rotor <sup>D</sup>	Storm SL.2						•	•									
	Storm HC	•	•		•	•			•		•	•	•				
	MDR-C	•	•	•	•	•			•	•	•	•	•				
	MDR-P	•	•	•	•	•			•		•	•	•				
<b>Anbau</b> Mounting	PM/IS	•	•	•	•	•	•	•	•	•	•	•	•				
	Flatmount						•		•				•				
	Canti													•	•	•	
<b>Befestigung Bremsbeläge</b> Brake pad mounting	Magnetisch mit Schraube Magnet with screw	•	opt.	opt.	•	• rear	•	•	•	•	•	•	•				
	Magnetisch ohne Schraube Magnet without screw	opt.	•	•	opt. front	• front											
	HS EPR											•	•	•	•	•	
<b>Leitung</b> Tubing	MAGURA disc tube	•	•	•	•	•	•	•	•	•	•	•	•				
	MAGURA tube													•	•	•	
<b>UVP/€ RRP/€<sup>E</sup></b>		219,90	109,90	114,90	579,90 (Set)	219,90 (Set)	279,90	179,90	89,90	94,90	59,90	169,90	129,90	109,90	89,90	69,90	

» Alle angegebenen Gewichte +/- 2% All given weights +/- 2%  
 » MT/HS: Kompatibel mit gängigen Shimano STI, SRAM Trigger und SRAM und Rohloff Drehgriffschaltern Compatible with standard Shimano STI, SRAM Trigger, SRAM and Rohloff twist-grip shifters  
 » 5 Jahre Garantie auf Dichtigkeit von Bremsgriff und Bremszange 5-year leak proof guarantee on masters and calipers  
 » Ausstattungsänderungen und Irrtümer vorbehalten  
 Product specifications are subject to change without prior notice

» <sup>A</sup> Gemittelttes Gewicht aus Bremse Vorderrad und Hinterrad  
 Average weight of front and rear brake  
 » <sup>B</sup> Gewicht pro Bremse, ohne Bremsscheibe und Adapter  
 Weight per brake, without rotor, without adapter  
 » <sup>C</sup> Gewicht pro Bremse Weight per brake  
 » <sup>D</sup> Empfehlung Recommendation  
 » <sup>E</sup> Ohne Bremsscheibe, ohne Adapter Without rotor, without adapter

# OEM PARTNERS

Atala

avea

BATAVUS

bergamont  
BICYCLES

BMC  
SWITZERLAND

BOSCH  
Technik fürs Leben

BULLS  
THE RIDE YOU WANT

CAMPUS

cannondale

CANYON

CENTURION

CONWAY

corratec  
PASSION OF CYCLING



CUBE

Diamant  
BEWEGT SEIT 1885

FEDDZ  
ELECTRIC RIBEL

FLYER  
Innovation In Mobility

EASYBIKE  
Group

easybike



FANTIC

FOCUS

Gazelle

GEPIGA

GHOST

GIANT

GITANE

Gudereit

HABIHE

HERCULES

HNF NICOLAI

idwork  
it works!

KALKHOFF  
MY BIKE



KLZVZF

KOGA

KREIDLER

KTM  
BIKE INDUSTRIES

LAPIERRE

LOOK

MAXX  
INDIVIDUAL BIKE SOLUTIONS

MERIDA

MONDRAKER

moustache

MTB CYCLETECH

MC  
MULTICYCLE

MUSUNG  
RAD-BAU-KUNST

M1-SPORTTECHNIK

norta

NOX  
CYCLES

ORBEA

PEGASUS

PEUGEOT  
CYCLES

PEXCO  
HIGH LEVEL MOBILITY

proactiv  
BIKE-TECHNOLOGY

PROPAIN

QWIC

RABENEICK  
weniger ist mehr

RIESE & MÜLLER



RIXE

ROSE

ROTHILD  
- 1884 - ESTABLISHED

SANTOS  
Built For Life

SIMPLON

SPARTA  
Something Special

SPECIALIZED

STAIGER

Steppenwolf

STEVENS

+STROMER-

tern

UNIVEGA  
RIDE IT YOUR WAY

URBAN  
ARROW

vanraam.com  
Let's all cycle

VELOVILLE  
das Velo!

VICTORIA  
HOVA / EST. 1886

vsi fahrradmanufaktur  
Premium-Mobilität

WHEELER  
WORLDWIDE

WINORA

xds 喜德盛

YAMAHA

yuba



# MAGURA NETWORK

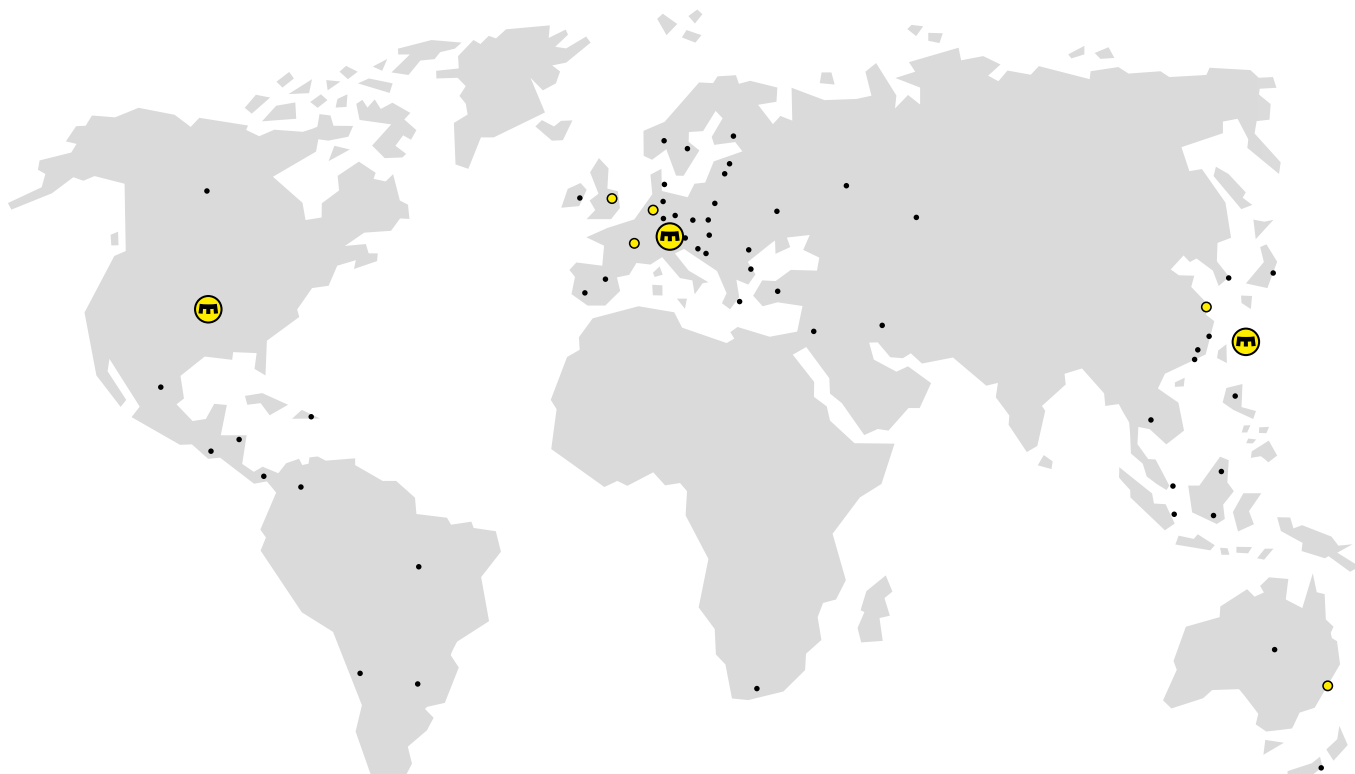

Follow us:



[facebook.com/magurapassionpeople](https://facebook.com/magurapassionpeople)



[instagram.com/magura\\_bicycle](https://instagram.com/magura_bicycle)

MAGURA Bosch Parts & Services GmbH & Co. KG  
Eckisstraße 6 · D-72574 Bad Urach, Germany  
+49 (0)7125 969460 · [info@magura.de](mailto:info@magura.de) · [magura.com](http://magura.com)

© MAGURA, All rights reserved · Printed in Germany  
18.000 · 2 702 551, 09/2021 · Features may be subject to change